



User Manual

SPIROLYSER[®] Q13[®]



CE
0459

Contents

1. Introduction	5
1.1. Supplied Equipment	5
1.2. Spirometer Presentation	5
1.3. Technical Features	6
1.4. Symbols	8
2. Safety	9
2.1. General	9
2.2. Description	9
2.3. Recommended Use	10
2.4. Users	10
2.5. Target population	10
2.6. Medical Contra-indications	10
2.7. Benefits, clinical performance and risks associated with use of the device	11
2.8. Serious Incidents or Risk of Serious Incidents	12
2.9. Potential adverse and side effects	12
3. Installation	12
3.1. Minimum Requirements	12
3.2. Software Use Conditions	12
3.3. Requirements	14
3.4. Installation Procedure	14
3.5. Database	18
3.5.1. SPIROWIN® EXPERT database	18
3.5.2. Retrieve data from old database	18
3.6. Spirometer Connection/Disconnection	19
3.7. Uninstallation	19
4. Use	20
4.1. Position the Single-Use Qflow® Sensor	20
4.2. Installing the SP1® / SP1M® single-use filter.	21
4.3. Eject the Single-Use Qflow® Sensor and the SP1® / SP1M® filter.	22
4.3.1. Eject QFlow® single-use sensor	22
4.3.2. Eject QFlow® single-use sensor and the SP1® / SP1M® filter.	23

4.4.	Presentation	24
4.4.1.	Main user interface	24
4.5.	Device Status Bar	25
4.5.1.	Presentation	25
4.5.2.	Organisation	25
4.6.	Initial Run	26
4.6.1.	Database choice	26
4.6.2.	Identification system	26
4.6.3.	Forgotten password	27
4.7.	SPIROWIN® EXPERT Home Page	28
4.7.1.	Presentation	28
4.7.2.	Home page main features	28
4.8.	ATS Recommendation	29
4.8.1.	Presentation	29
4.8.2.	Setting	29
4.8.3.	Forced Vital Capacity test	29
4.8.4.	Reports	30
4.8.5.	Export	30
4.9.	Test Creation	30
4.9.1.	Test initialisation	31
4.9.2.	Slow Vital Capacity Test	32
4.9.3.	Forced Vital Capacity test	33
4.9.4.	Maximum Voluntary Ventilation test	34
4.9.5.	Test Assessment (This screen can be masked in the parameters)	35
4.9.6.	Interpretation	37
4.10.	Test Management	45
4.10.1.	Test Management screen presentation	45
4.11.	Identification Management	46
4.11.1.	Add a new file	46
4.11.2.	Modify an existing file	46
4.11.3.	Delete a file	47
4.11.4.	File search	47
4.11.5.	Patient file	47
4.11.6.	Smoking Pack Year	48
4.11.7.	Operator file	49
4.11.8.	Company file	49
4.12.	Test Comparison	50
4.12.1.	Comparison presentation	50
4.13.	Device Calibration Check Certificate	52
4.13.1.	ATS 2005 recommendations check procedure	53
4.14.	Application Parametering	54
4.14.1.	Presentation	54
4.14.2.	General	54

4.14.3.	Guest mode	55
4.14.4.	Tests	55
4.14.5.	Printing	56
4.14.6.	Automatic PDF and CSV export	56
4.14.7.	Incentive	56
4.15.	User Manual	56
4.16.	Third Party Software Use Mode (GUEST Mode)	57
4.16.1.	Presentation	57
4.16.2.	Table of available commands	57
4.16.3.	Host mode	57
4.16.4.	Use of local database	59
4.16.5.	Polling mode	59
4.16.6.	Icon mode	59
5.	Cleaning – Maintenance	59
5.1.	List of Generic Bactericidal Fungicidal Products Validated by FIM MEDICAL	59
5.2.	Clean the Housing	60
5.3.	Clean the Sensor Insertion Piece	60
5.4.	Clean the Check Syringe	60
5.5.	Daily Check	61
5.6.	Annual Maintenance	61
5.7.	Guarantee	61
5.8.	. Lifetime	61
6.	Available Accessories	62
6.1.	Litre Check Syringe	62
6.2.	Qflow® Single Use Sensor	62
6.3.	SP1® / SP1M® filter	62
6.4.	Single Use Nose Clip	62
7.	F.A.Q.	63

1. Introduction

1.1. Supplied Equipment

The following equipment should be found when the package is opened:

- SPIROLYSER® Q13® device with its USB lead
- CD containing the User Manual as well as the SPIROWIN® EXPERT software
- Information sheet
- Check certificate

Note: The SPIROLYSER® Q13® should be returned to After Sales Service (for calibration or other interventions) in its original packaging with all the cushioning material. Repairs will not be considered under warranty without the original packaging box.

1.2. Spirometer Presentation

The SPIROLYSER® Q13® is an electronic spirometer operating on a PC, for the exploration of respiratory function.

The spirometer is composed of a single-use sensor that propels the air (FLEISCH principle) and obtains a difference in pressure. The SPIROWIN® EXPERT software acquires samples sent by the spirometer and determines a flow and a volume so as to display the curves and deduce results.

The SPIROLYSER® Q13® spirometer is a portable device. In normal use, the patient holds it by the handle, placing the single-use sensor in the mouth. It can be used with or without the SP1® /SP1M® antiviral and antibacterial filter.

The SPIROLYSER® Q13® is directly powered by the computer USB port via its USB lead.



Figure 1. USB plug



The SPIROWIN® EXPERT software calculates, displays and stores data to help the practitioner in the exploration of a patient's respiratory function.

1.3. Technical Features

SPIROLYSER® Q13® Technical Features	
Tests	Slow and Forced Vital Capacity, Maximum Voluntary Ventilation, Post-medication
Sensor	Fleisch type digital pneumotachograph
Flows Measurement Range	-14L/s to +14L/s
Volume Measurement Range	0L to 10L
Digital Resolution	15 bits
Measurement Accuracy	± 3% maximum
Lead Length	3 metres
Storage Temperature	0 - 50°C
Temperature for Use	17 - 35°C
Atmospheric Pressure	850 - 1060 hPa
Humidity	75% maximum
Operational Altitude	< 2000 metres
Voltage	5VDC (via USB port)
Current	200mW maximum
Reference Standards	EN 60601-1, EN 60601-1-2, IEC 60601-1-6, EN 62366-1, EN ISO 10993-1, EN ISO 10993-5, EN ISO 10993-10, NF EN ISO 14971, NF EN 62304/A1, ISO 20417, EN ISO 15223-1 NF EN ISO 13485, NF ISO 2859-1, ATS 2005
Medical Class	Ila
Software security class	A
Marking	CE
Electrical class	Class I
GMDN spirometer code	35282
GMDN Qflow® code	61097
Applied Part	Type BF (Qflow® sensor and device shell)
Size	90x180x60mm
Device Weight	250g

Year of first EC marking : 2015

QFlow® Sensor - product characteristics:	
Storage temperature	Between 0 and 50°C
Operational temperature	Between 17 and 35°C
Dimensions	120x50*50 mm
Weight	18 grams
Resistance at 14L/ s ⁻¹	1.35 cmH ₂ O/(L/sec)
Reference recommendations	ATS 2005
Reference standards	EN ISO 10993-1, EN ISO 10993-5, EN ISO 10993-10, NF EN ISO 14971 ISO 20417, EN ISO 15223-1, NF EN ISO 13485, NF ISO 2859-1
Medical class	Ila (rule 5)
CE	Marking
Applied part	Type BF (sensor)
Qflow GMDN Code	61097

EC marking acquired in: 2015

NB: For SP1® and SP1m® filter specifications, refer to the filter User Manual.

Nose clip characteristics:	
Storage temperature	Between 0 and 50°C
Operational temperature	Between 17 and 35°C
Reference standards	EN ISO 10993-1, EN ISO 10993-5, EN ISO 10993-10, NF EN ISO 14971 ISO 20417, EN ISO 15223-1, NF EN ISO 13485, NF ISO 2859-1
Medical class	I (rule 1)
GMDN Code	10907

Year of market introduction: 2015

1.4.Symbols

The "serial number" or cardboard labels have the following markings:



CE marking 93/42/CEE or MDR 2017/745 directive + N° of notified body



Type BF applied part



Must not be discarded with usual household waste. To discard this product at the end of its life, contact the manufacturer.



Consult accompanying documents

SN

Serial number



Manufacturer identification



Lot number



Expiration date of use



Do not reuse. Single-use.



Storage temperature to respect



Date of Manufacture



Humidity Level Limit



Medical Device

2. Safety

2.1.General

Caution:

- Do not use the SPIROLYSER® Q13® in a non-medical environment
- The product should be used on healthy skin
- Only use the SPIROLYSER® Q13® with the single-use Qflow® sensors intended by the manufacturer
- When using an additional filter, use only the SPIROLYSER® Q13® with SP1® or SP1M® single-use filters.
- When using an SP1®/SP1M® filter, indicate in the test setup that the SPIROLYSER® Q13® is used with a filter.
- Do not dismantle or handle the internal components
- No modification of equipment is authorised
- Do not use or connect the SPIROLYSER® Q13® in an explosive environment or in the presence of anaesthetic gases
- Do not pull on the leads
- Do not make sudden movements when the sensor/device is positioned in the mouth
- Do not let the computer and SPIROLYSER® Q13® leads trail on the ground and become tangled. This could cause the device to fall off the table or deteriorate the electrical connections
- To avoid problems of electromagnetic or other interference with other devices, do not use the SPIROLYSER® Q13® in surroundings with interferences, or too close to other devices
- Never clean the SPIROLYSER® Q13® with running water or immerse it directly in any liquid. Do not splash or wet the device with any liquid.
- Always use the SPIROLYSER® Q13® linked to a computer that conforms to the IEC 60950-1 standard or IEC 62368-1
- For safety reasons, access to the computer USB lead plug should remain accessible
- The Spirolyser® Q13® is not designed for anaesthetic and respiratory use.
- The performance of the SPIROLYSER® Q13® can be affected if the patient spits or coughs into the SPIROLYSER® Q13® during exhalation or by extreme temperature, humidity and altitude conditions.

2.2.Description

The Spirolyser® Q13® is an electronic medical device with the following components:

- A SPIROLYSER® Q13® device
- A single-use/disposable QFLOW® sensor
- The SPIROWIN® EXPERT software suite (integrated into the Spirolyser®)
- A nose clip
- SP1® and SP1m® filters (optional).

2.3. Recommended Use

The SPIROLYSER® Q13® is a computerized digital spirometer allowing the exploration of a patient's respiratory function and the detection of respiratory disorders and pathologies. The patient can be a child or an adult (men and women) aged 4 to 95 years.

The single-use/disposable Qflow® sensor enables converting the airflow into defined data measurements (the transfer function between the airflow and the data). It is designed specifically to work with the FIM MEDICAL spirometer.

The nose clip is to prevent air from passing through the nose during the examination.

2.4. Users

Spirolyser® Q13 is reserved exclusively for healthcare professionals (medical secretary, nurse, doctor, pneumologist, lung specialist...) having followed a recognized and complete training on the use of spirometers and the interpretation of spirometric results.

Given the level of education of health professionals, the device does not present any difficulty in its use.

The operator must be sufficiently trained in the use of computers and the associated operating system.

The operator must be made aware of the rules of hygiene and bacterial contamination.

If in doubt, the healthcare professional should refer to the User Manual and/or contact the FIM MEDICAL company or its distributor.

2.5. Target population

The Spirolyser® Q13® device is designed to be used by the following population:

- Persons aged 4 - 95 years.
- Wishing to have spirometric measurements to assess their respiratory capacities
- And not suffering from any contraindication associated with their respiratory situation

2.6. Medical Contra-indications

Indication: The Spirolyser® Q13 ® is used to explore respiratory function and to detect respiratory disorders or diseases.

It is strictly prohibited to perform respiratory function tests in the following cases:

- Recent or current pneumothorax
- Recent puncture or pleural biopsy
- Current haemoptysis
- Severe or sudden asthma attack

- Smear-positive tuberculosis (risk for personnel)
- Bronchial infections, infectious pneumopathy
- Decompensation of chronic respiratory insufficiency
- Impossibility to carry out manoeuvres; ventilatory motor incoordination
- Abnormal pain, fatigue
- Myocardial infarction < 6 months
- Laparotomy < 6 months
- Nasopharyngitis and hypertension controlled on the day of the examination

2.7. Benefits, clinical performance and risks associated with use of the device

After several years of proven experience with older generation devices, the SPIROLYSER® Q13 device claims its qualities both in terms of technical performance (accuracy of measurements) and screening (quality of tests).

The device allows operators to detect the following respiratory pathologies:

- Small airway disease / syndrome (SAD / SARS)
- Obstructive Ventilatory Disorder (OVD)
- Restrictive Ventilatory Disorder (RVD)
- Mixed Ventilatory Disorder
- Different levels of chronic obstructive pulmonary disease / respiratory disease (COP / AD).
The Spirowin® Expert software includes a "GOLD" interpretation aid
- Asthma according to the "GINA" programme

The performance, technical features, measurement accuracies and compliance with ATS 2005 recommendations of the Spirolyser® Q13® spirometer with accessories and Spirowin® Expert software ensure a qualitative clinical benefit in patient diagnosis. Accurate calculation of spirometric parameters combined with interpretation aids allow the diagnosis of different types of respiratory diseases and their states of progression.

Diagnostic assistance through the detection of respiratory disorders or pathologies allows for therapeutic orientation in order to improve access to care, which in turn has a positive impact on patient health care or public health.

The Q13® spirometer is biocompatible and non-invasive. It is considered to be low-risk due to the technology used, the time of use and the therapeutic indication. The Qflow® single-use sensor and nose clip are biocompatible and single-use accessories that provide protection against bacterial and viral risks between 2 patients.

2.8.Serious Incidents or Risk of Serious Incidents

In the event of an incident or risk of serious incident related to the device, health professionals or users may make a declaration to the competent authorities. In any case, the manufacturer must be notified as soon as possible, so as to report and deal with this materio-vigilance case.

2.9.Potential adverse and side effects

No adverse events or incidents related to clinical performance, clinical safety or usability have been reported since the Spirolyser® Q13® marketing. The reported complaints were only related to device failure or logistical issues with no impact on clinical performance or safety.

Therefore, FIM MEDICAL does not claim any potential adverse and/or secondary effect(s) from use of the Spirolyser® Q13® device.

3. Installation

3.1.Minimum Requirements

- Supported operating systems: **Windows 7, Windows 8, Windows 8.1, Windows 10, Windows 11.**
- Processor 3 Ghz for single core or 1 Ghz for dual core or higher (32-bit (x86) or 64-bit (x64)).
- 1 gigabyte (GB) (32-bit) or 2 GB (64-bit) RAM.
- A hard disk with 16 GB of available space (32-bit) or 20 GB (64-bit) for the operating system.
- 3 GB of free hard disk space for the software.
- A graphic board (or graphic chipset) with minimum resolution of 1024x748 and 256 MB of RAM (graphics hardware acceleration for incentive)
- A screen with minimum resolution of 1024x748
- Built-in USB 2.0 port and powered by the computer.

3.2.Software Use Conditions

The SPIROWIN® EXPERT software is licenced under the following conditions. If, before installation, or 48 hours after receipt of the software, you refuse these conditions, please return it to the distributor who sold you the product, to obtain a refund.

Use implies your entire agreement of the following conditions:

The software supplied under licence remains the property of FIM MEDICAL who grants the right to use the product, on condition the present conditions are respected.

This licence is granted for installation on one workstation only (desktop computer, laptop or terminal).

All new installations require the purchase of extra licences, or uninstallation of the programme on the initial workstation. The licence is nominative; if the device is no longer used, please refer to the supplied licence contract for the procedure. Copy or reproduction of the FIM MEDICAL software supplied under licence is prohibited. Reproduction, even partial, of the screens or computer processes constitutes a violation of this agreement. You agree to take all the necessary measures to avoid pirated copies or use by unauthorized third parties.

The FIM MEDICAL company can in no way be held responsible for any malfunction related to the installation of one of its software programmes on a computer. Nor can the FIM MEDICAL company be held responsible for consequences related to the installation of one of its software programmes, such as partial or total data loss.

The user should be trained in the basic rules of computer use, and will take all precautions against the risk of software pirating, the distribution of confidential data, infiltration of whatever type of computer virus, or incorrect use.

The user shall take special care to back up data recorded on the computer as often as possible on a reliable support. FIM MEDICAL recommends daily backups.

3.3.Requirements

List of packages installed with the SPIROWIN® EXPERT software:

- Microsoft Dot. Net Framework 4.0 Full
- Microsoft Dot. Net Framework Language Package 4.0 (French, Italian, German, Spanish, Dutch, Portuguese)
- Microsoft Access database engine redistributable
- Microsoft Sql Server Compact Runtime 4.0

Adobe Reader V9 minimum software is required to read the manual from the software.

3.4.Installation Procedure

Note: You must be in administrator mode to install SPIROWIN® EXPERT.

1. Insert the SPIROWIN® EXPERT installation CD.
2. Run the installation.
3. Choose the software and installation language.

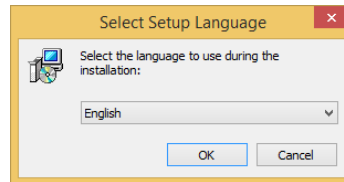

4. Click «OK».



5. Click «Next».
6. Enter the SPIROWIN® EXPERT install key, located on the back of the CD sleeve.

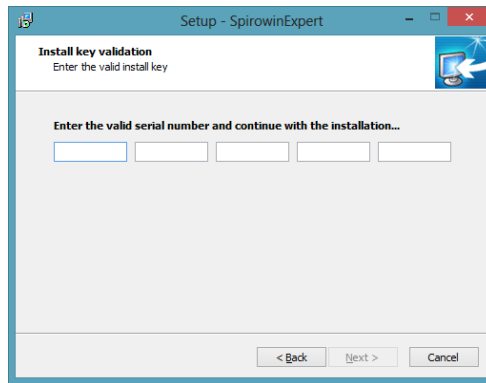

7. Click «Next».

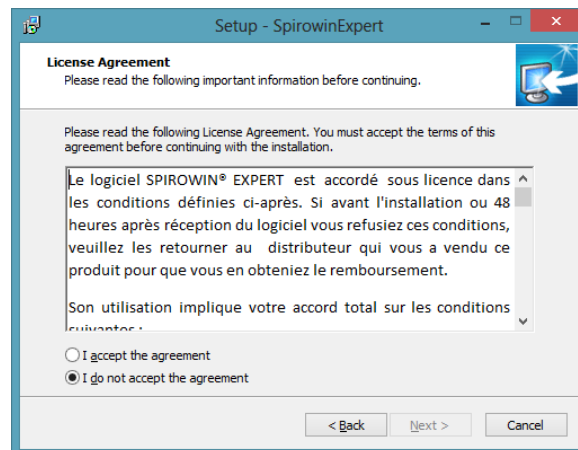

8. Accept the licence contract terms.

9. Click «Next».

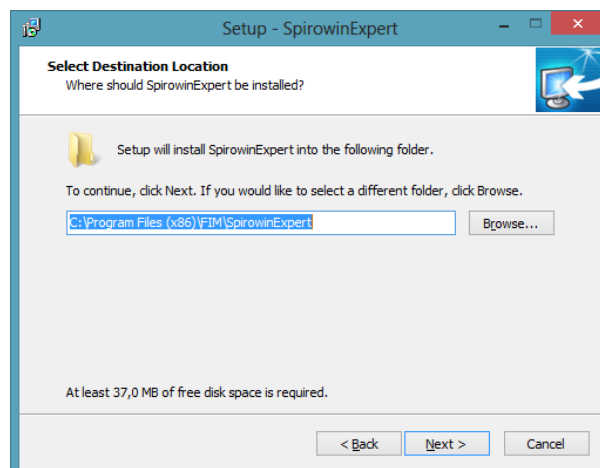

10. Modify the install path if necessary.

11. Click «Next».

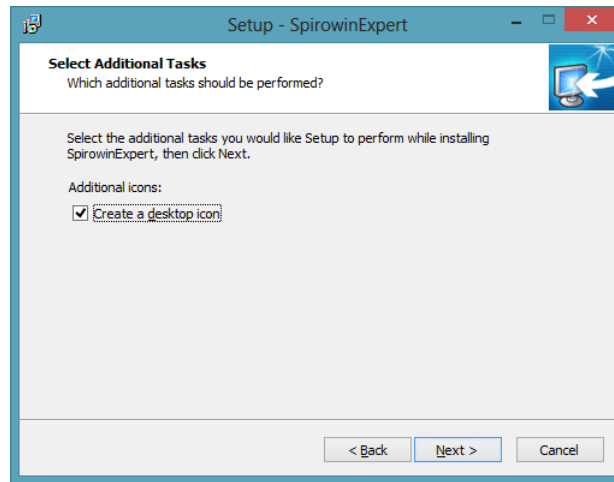

12. Click «Next».

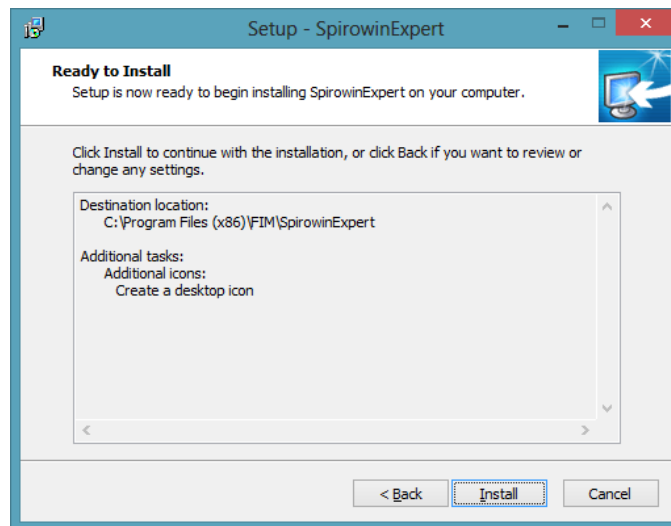

13. Click «Install».

14. Installation of SPIROWIN® EXPERT is in progress.

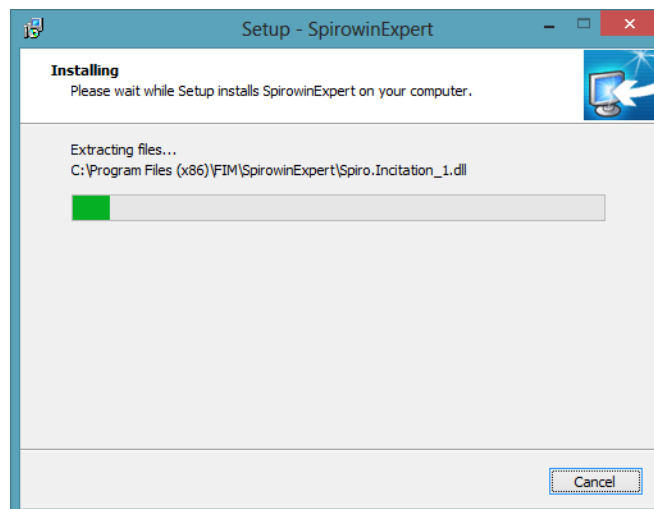

15. Click «Finish».

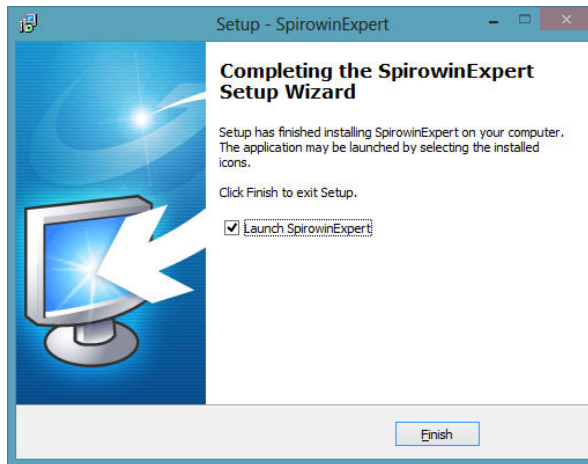

3.5.Database

3.5.1. SPIROWIN® EXPERT database

SPIROWIN® EXPERT can use two database formats:

- A local database (SQL Compact Server) file type
- A distant database (SQL Server)

When the application is first run, you can choose the database type. You can also migrate from one base to another, from the software.

3.5.2. Retrieve data from old database

If you have an old FIM MEDICAL database (fim.mdb type), you are able to:

- Retrieve old patient identification
- Synchronize patient identification between two databases (other FIM MEDICAL software)
- Retrieve old tests from Spirowin V6

To do this, click «Synchronize with old database» in the settings software panel (after install).

Synchronization with old FIM
MEDICAL database

Synchronize with old database

Then choose your fim.mdb file.

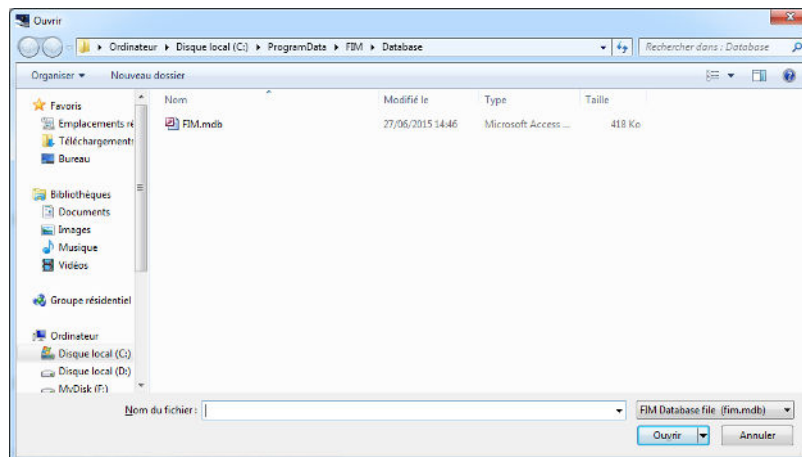

Click “Open” and wait for the end of process to retrieve old patient identification.

If old tests are detected in a database, a window appears with the choice of import.

After import, save synchronization with old database by clicking “Save settings”.

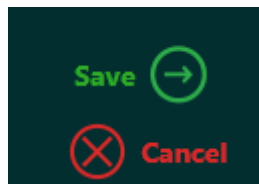

Note:

- If fim.mdb file is deleted later, the software automatically stops synchronization
- Import errors are written in log file in C:\ProgramData\FIM\SpirowinExpert
- SQL Server format does not allow permanent synchronization with an old database

3.6. Spirometer Connection/Disconnection

The spirometer should be connected to the computer via the USB plug.

Spirometer connection is displayed on the screen.

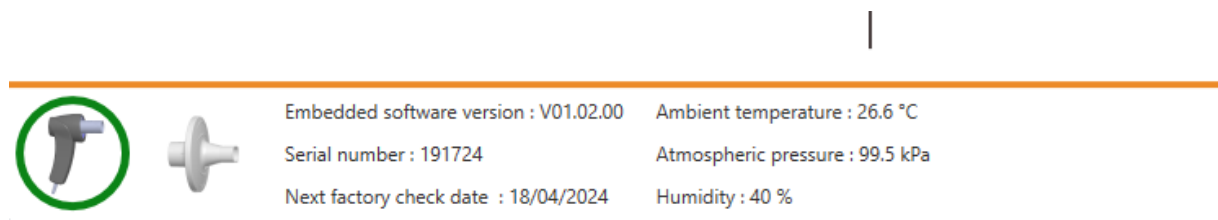

To disconnect the device, remove the USB lead from the computer. The device is no longer connected.

3.7. Uninstallation

SPIROWIN® EXPERT can be uninstalled from your computer if you no longer use it. Use «Programmes and Features» to uninstall programmes.

1. Open «Programmes and Features» in the Windows Control Panel. Click «**Programmes**», then «**Programmes and Features**» (Note: access to the uninstallation panel may vary according to different Windows versions).
2. Select **SPIROWIN® EXPERT** then click «**Uninstall**».

Note: For security reasons, the database will never be deleted when the software is uninstalled.

4. Use

4.1. Position the Single-Use Qflow® Sensor

Qflow® sensors are single-use sensors specifically developed to operate with the SPIROLYSER® Q13® spirometer.

Qflow® sensors are designed and adapted for respiratory function exploration tests (spirometry); their resistance does not exceed the ATS/ERS recommendations.

Qflow® sensor installation:

- Locate the dotted line opening part
- Hold everything with one hand by the mouthpiece side (small side of packaging)
- With the other hand, open the detachable part of the Qflow® packaging along the dotted line
- Insert the Qflow® into the opening of the sensor until it stops
- Remove and discard the rest of the packaging

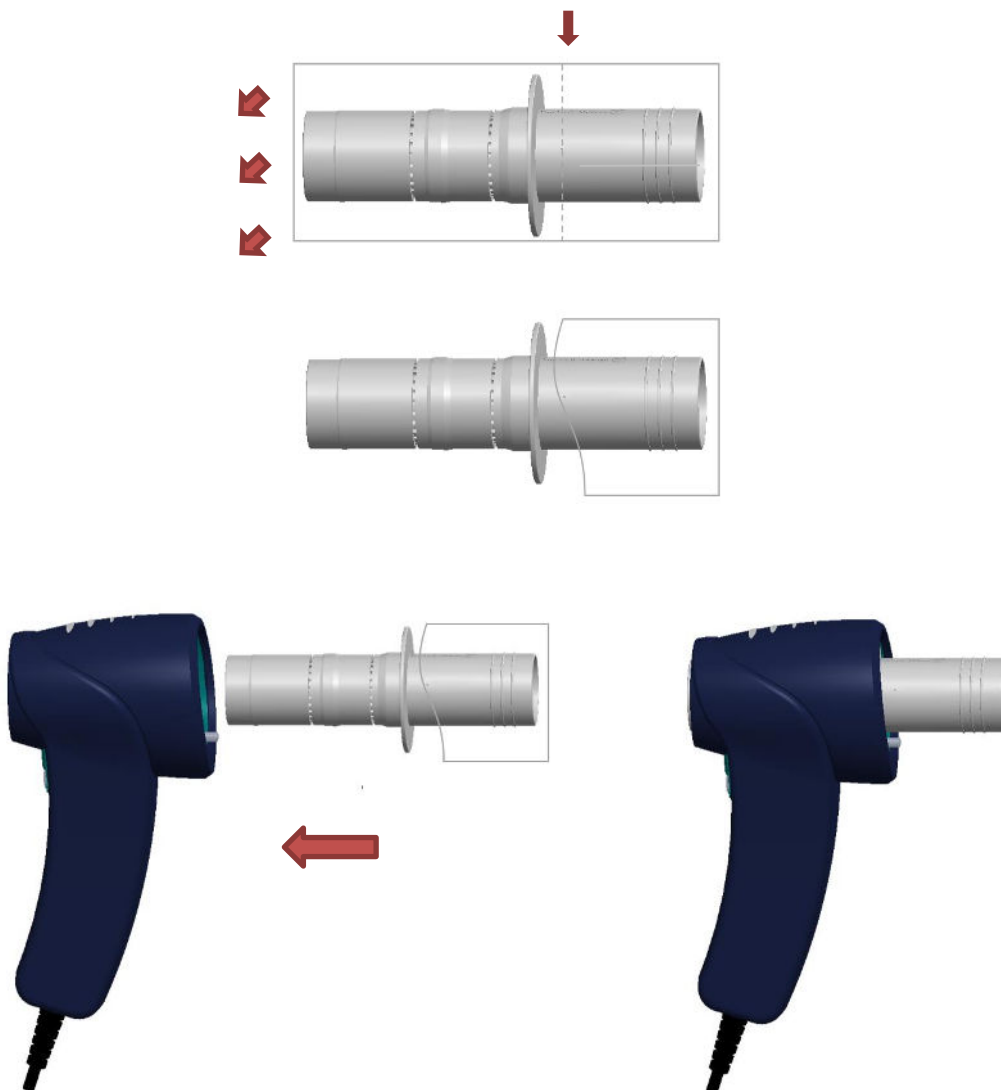

4.2. Installing the SP1[®] / SP1M[®] single-use filter.

The SP1[®] and SP1M[®] are disposable filters developed specifically for the SPIROLYSER[®] Q13[®] spirometer.

SP1[®] / SP1M[®] filter installation:

- Open the filter bag without touching the mouthpiece to avoid contaminating it.
- Insert the filter into the Qflow[®] tube all the way.
- Discard the packaging.

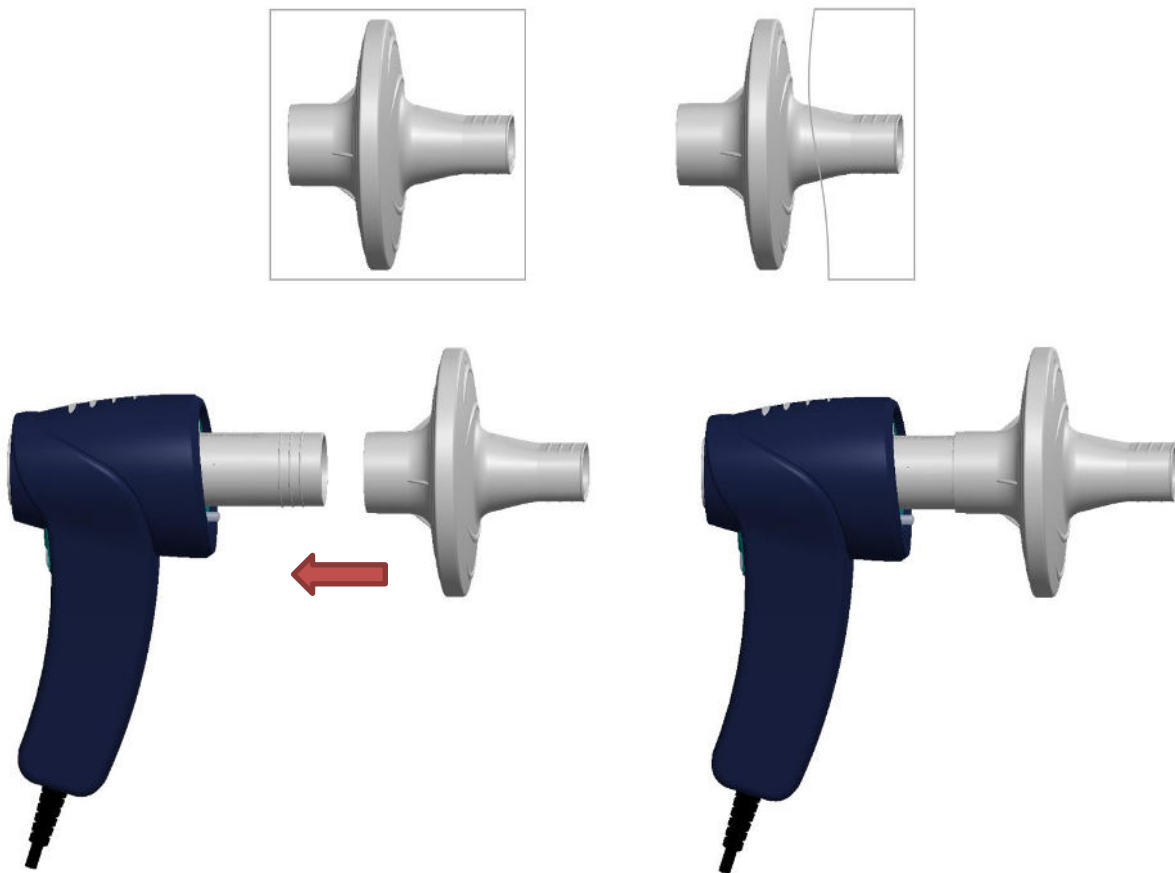

4.3. Eject the Single-Use Qflow® Sensor and the SP1® / SP1M® filter.

At the end of a patient's tests the single-use sensor must systematically be removed and discarded. The device is equipped with a no-contact ejection system. The sensor is thus ejected without the operator having to touch it.

4.3.1. Eject QFlow® single-use sensor

Hold device downwards over a rubbish bin and push the trigger upwards.

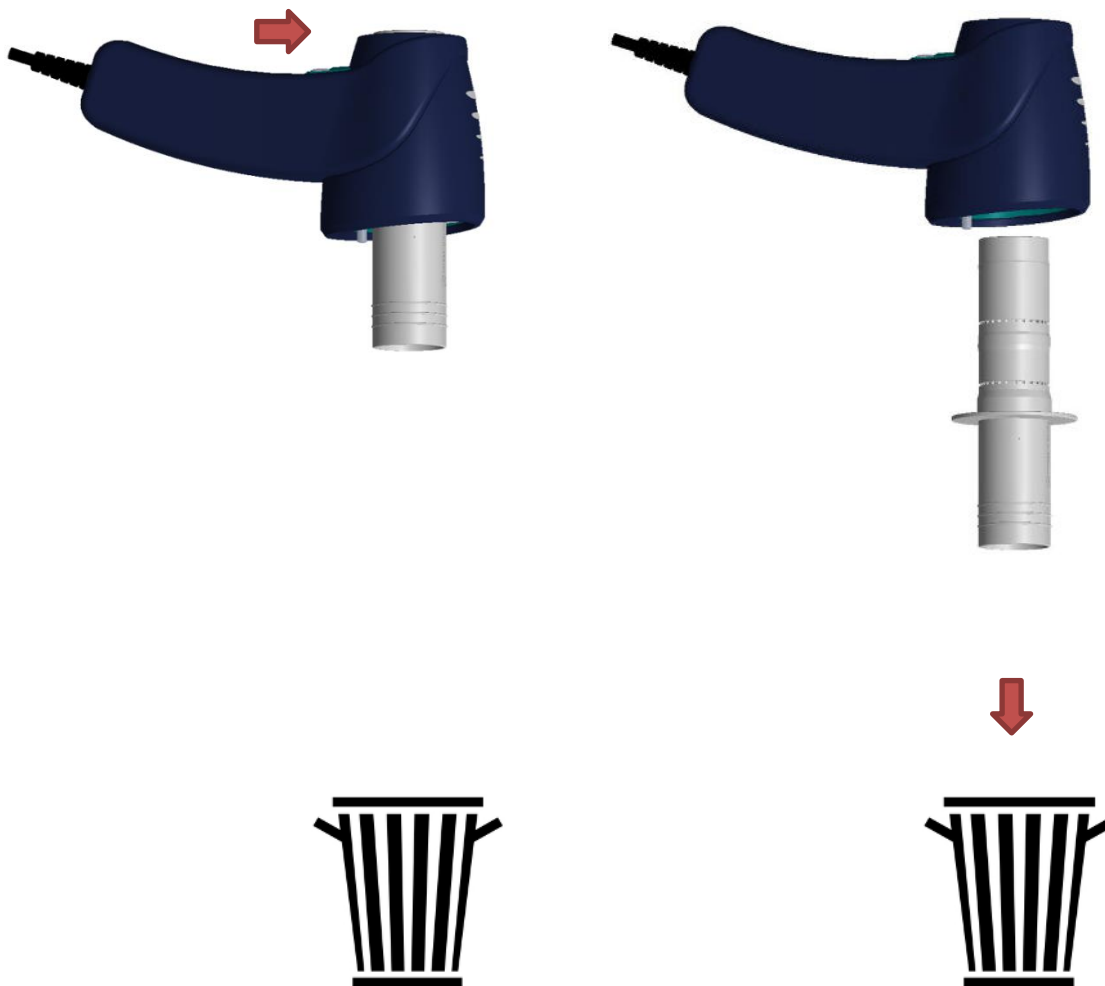

Note: Used accessories should be included in a separate collection for biologically contaminated waste (PIMW: potentially infectious medical waste).

4.3.2. Eject QFlow® single-use sensor and the SP1® / SP1M® filter.

Hold device downwards over a rubbish bin and push the trigger upwards.

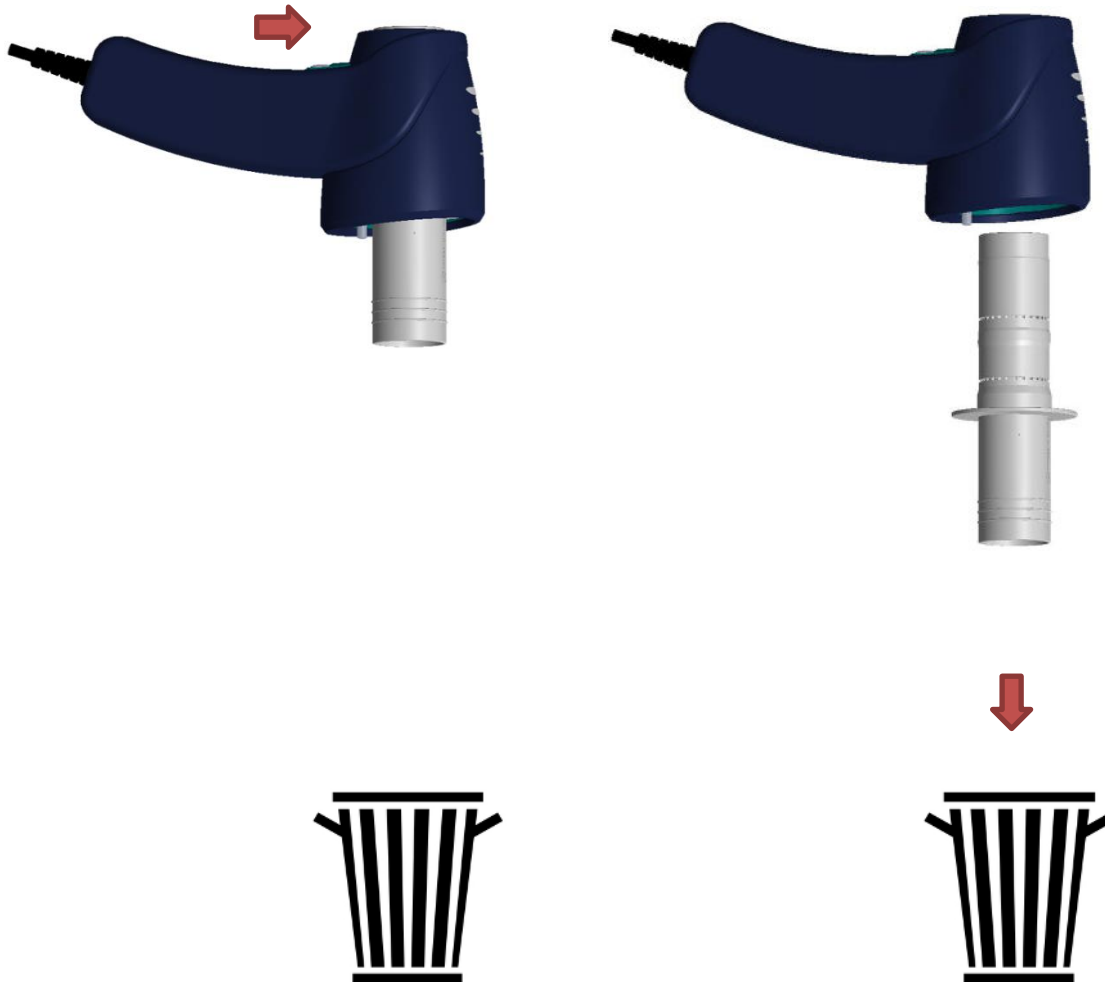

Note: Used accessories should be included in a separate collection for biologically contaminated waste (PIMW: potentially infectious medical waste).

4.4.Presentation

SPIROWIN® EXPERT is spirometry software. It is used in association with the SPIROLYSER® Q13® sensor to perform tests to help the practitioner in the respiratory function exploration of a patient.

Its user-friendly interface has been specifically studied and designed to help the operator to screen possible respiratory illnesses within the field of preventive medicine.

Using this application, the operator can identify a patient, perform spirometric tests such as Slow Vital Capacity, Forced Vital Capacity and Maximum Voluntary Ventilation. The operator can print test reports and compare them over time.

4.4.1. Main user interface

The spirometry software user interface is designed as follows:

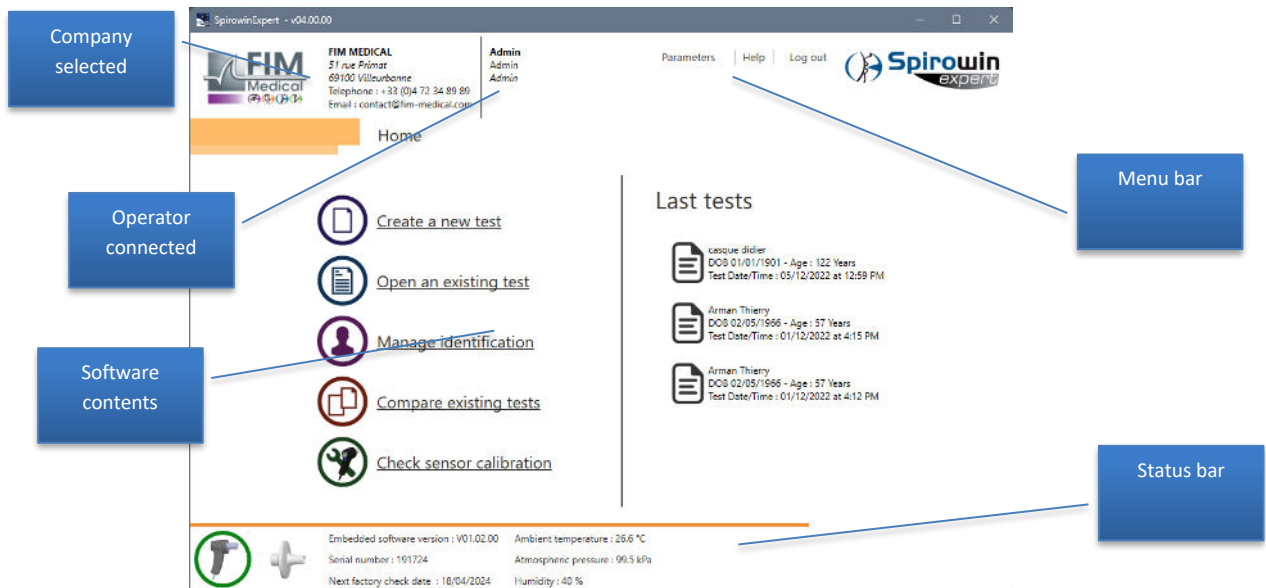

4.5. Device Status Bar

4.5.1. Presentation

The status bar shows the operator the device features and other extra information.

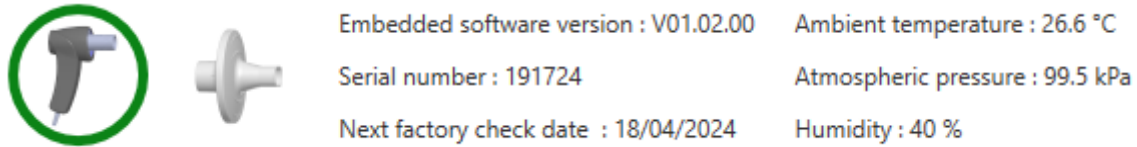

4.5.2. Organisation

List of parameters displayed in the status bar:

Name	Unit	Description
State of connection	-	Displays a logo showing the communication state between the software and the device
Filter status.	-	Displays a logo indicating whether or not a filter was used during the test.
Firmware version	VXX.XX.XX	Displays the version of embedded software in the device
Serial number	XXXXXXXX	Displays the device serial number. (identical to type label)
Date of next factory check	-	Display of next return date of device to manufacturer
Ambient temperature	°C/°F	Ambient temperature of device handle
Atmospheric pressure	kPa/mmHg	Ambient atmospheric pressure of device handle
Humidity	%	Level of air humidity in the device handle

Note: Meteorological parameters are updated regularly. Device information is initialised only when the sensor is connected or when the application is run.

Warning: The sensor factory check date indicates the date by which the device must be returned to the manufacturer for a complete check up. If this date expires, you will receive an automatic alert in red that **FIM MEDICAL declines all responsibility for possible measurement errors.**

4.6.Initial Run

The software initial run requires particular attention.

4.6.1. Database choice

During the initial run the operator chooses a database type (default choice is SQL Compact in local mode)

If an old database is detected, you may keep a synchronization of patient files.

If the SPIROWIN® V6 software is detected, you can also import old tests.

4.6.2. Identification system

For the safety of medical data, SPIROWIN® EXPERT uses an operator identification system. The system requires a password supplied upon creation of each operator account.



For the initial application run, an account can be made directly from the identification screen. Other operator accounts can be made with the relevant interface. The password protection system can be disabled. Access can be memorised with an account of your choice so no need to re-identify.

Operator identification

Identity	Access Control
First name <input type="text"/> <i>Empty field</i> <i>Field must have between 2 and 50 characters</i>	Password <input type="text"/> <i>Empty field</i> <i>Field must have between 6 and 10 characters</i>
Last Name <input type="text"/> <i>Empty field</i>	Password confirmation <input type="text"/> <i>Empty field</i>
Occupation <input type="text"/>	Reset Password
Operator Quality Code None	Answer question to reinitialise password
Reviewer <input type="checkbox"/>	Question What is the name of your first pe
	Answer <input type="text"/> <i>Empty field</i>
	<input type="button" value="Cancel"/> <input type="button" value="Save"/>

Once identified, the operator can access all the application functions. To protect access, or change operator, click on the «Disconnection» button in the secondary menu bar.

4.6.3. Forgotten password

If the password associated with your operator account is forgotten or lost, it can be reset by giving the same response to the question chosen when your account was created.

1. Choose your user account.
2. Click «Password forgotten?».

SpirowinExpert - v04.00.00

FIM MEDICAL
51 rue Primat
69100 Villeurbanne
Telephone : +33 (0)4 72 34 89 89
Email : contact@fim-medical.com

Parameters | Help | Log out

Spirowin expert

Home

Password forgotten?

Operator
MOTOT
Sandy
devine

Check question:
In what town were you born?

Answer

Answers are not the same
Empty field

New password:
Empty field
Field must have between 6 and 10 characters

Confirm new password:
Empty field

Ok Cancel

Embedded software version : V01.02.00 Ambient temperature : 26.5 °C
Serial number : 191724 Atmospheric pressure : 99.5 kPa
Next factory check date : 18/04/2024 Humidity : 40 %

3. Answer the question and enter your new password in the relevant fields.
4. Click «OK»

Note: An administrator account (unmodifiable) permits interface access if operator identification information is lost. Contact the manufacturer, FIM MEDICAL for instructions.

4.7.SPIROWIN® EXPERT Home Page

4.7.1. Presentation





The interface is designed to be simple, with easy access. For this, all the application features are performed from the Home page:



4.7.2. Home page main features

4.7.2.1. Presentation

Direct access to SPIROWIN® EXPERT application features

-  [Create a new test](#)
-  [Open an existing test](#)
-  [Manage identification](#)
-  [Compare existing tests](#)
-  [Check sensor calibration](#)

4.7.2.2. Organisation

Name	Description
Create a new test	Enter into the process to create a new test
Open an existing test	Enter into the management of existing tests
Manage identifications	Enter into the management of application identifications
Compare tests	Compare results of several tests from the same patient
Check sensor calibration	Check sensor calibration according to ATS recommendations

4.8.ATS Recommendation

4.8.1. Presentation

SPIROWIN® EXPERT offers the option of selecting the "ATS 2005" recommendations. Use of these recommendations is defined in the application settings options (see §4.14) to determine test quality.

4.8.2. Setting

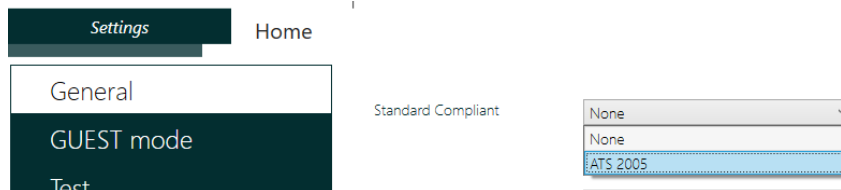

Note: If the "ATS 2005" recommendations is enabled, when saving the application settings, a message appears prompting you to check other settings, in particular:

- Choice of "NHanes III" predicted value
- Displayed report "ATS Report (superimposed Curves)"

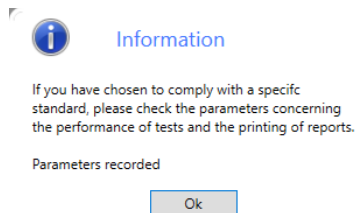

4.8.3. Forced Vital Capacity test

When the recommendation "ATS 2005" is activated, the Forced Vital Capacity test is completed by two tables:

Results	Value	Standard	% Standard	Z-score	Z-score percentage
FVC	345 L	348 L	96.77 %	-	-
RV	320 L	322 L	99.31 %	-	-
RV	340 L	338 L	100.61 %	-	-
FEV1	250 L	245 L	102.04 %	-	-
FEV1/FVC	80.32 %	80.21 %	100.12 %	-	-
FEV1	2.98 L	-	-	-	-
FEV1/FVC	4.31 L	3.45 L	125.01 %	-	-
FEV1/FVC	1.18 L	0.99 L	119.19 %	-	-
FEV1	0.71 L	-	-	-	-
FEV1	2.98 L	-	-	-	-

- Table displaying the acceptability criteria of a curve. Indeed, for each curve, the operator can check certain test qualitative criteria by clicking on check boxes:
 - Without disturbance: patient performed the test without disturbance during the procedure (e.g. obstruction, swallowing, premature end of test, etc.).
 - Extrapolated Volume: patient achieved a good start of exhalation during the procedure. Calculated automatically, the operator can change this box in case of discrepancy.
 - Satisfactory expiration: patient has performed a sufficiently long procedure or reached a plateau. Calculated automatically, the operator can change this box in case of discrepancy.
 - Acceptable curve: operator estimates whether the curve is considered acceptable and will be used to determine the quality of the test (taken into account for calculation of reproducibility criteria).
- Table representing reproducibility criteria: Reproducibility criteria is based on calculations provided by the ATS and are on a scale of A to F.
 - FVC quality code: Quality level of Forced Vital Capacity measurement on all the acceptable curves.
 - FEV1 quality code: Quality level of Forced Expiratory Volume measurement after one second over all acceptable curves.

4.8.4. Reports

When the "ATS 2005" recommendations is activated, 2 new printable reports are available and can be set up in the software setting:

- ATS report (superimposed curves)
- ATS report (separated curves)

These reports have been specifically designed to respond to the "ATS 2005" recommendations and introduce the notion of Lower Limit of Normal (LLN). This introduces two new indicators to qualify the test and guide interpretation accordingly.

4.8.5. Export

The aforementioned reports can also be exported in PDF format manually or automatically (set up in the software setting) at the end of the test.

4.9. Test Creation

SPIROWIN® EXPERT proposes a totally new method of performing a spirometric test to that of the existing Spirowin® software.

SPIROWIN® EXPERT presents a process defined by a series of screens to help the operator perform spirometry tests. List of series of screens presented:



4.9.1. Test initialisation

In this first stage, information required for performing a test is input. List of information entered by the operator:

- Choice of patient file or creation of a new file
- Choice of tests to perform (VC, FVC, MVV)
- Choice of using a filter.

Note: The choice of tests to perform is saved for the next tests.

Input information on the form of the following screen to create a new file. If you have selected an existing file from the list, it will be modified.

4.9.1.1. Interface presentation

The screenshot shows the 'SpirowinExpert - v04.03.00' application window. The main area is titled 'Patient identification' and contains several input fields: Last Name, First name, DOB (23/05/2023), ID, Height, Weight, Gender, Ethnic group (Caucasian), Smoker (Non-smoker), Company, Department, Occupation, and Exposure. There are also 'Examination requirements' with radio buttons for 'Do you use a filter during examination?' (Yes/No). A 'List of existing patients' is shown on the right, with a search bar and a list of names and DOBs. A 'Control Panel' on the right side has 'Test options' (Vital Capacity, Forced Vital Capacity, Maximum volume per minute) and a 'New patient' button. Blue callout boxes point to these elements: 'Patient identification', 'Patient search from the list', 'List of existing patients', 'Choice of tests (choice saved after recording)', and 'Control Panel'.

Caution: The SPIROLYSER® Q13® can be used with an SP1® or SP1M® filter. Spirometry measurements are adapted according to the use of a filter or not. Before each test, you will be asked to specify if a filter is used or not during a spirometry test.

Note: Meteorological parameters are retrieved by the SPIROLYSER® Q13®. However, to obtain more precise measurements, you may wish to equip yourself with your own weather station and enter the data manually (option in software parametering).

4.9.2. Slow Vital Capacity Test

Slow Vital Capacity is a spirometric test that measures the amount of air that can be slowly exhaled after inhaling as deeply as possible, and is mainly used to quantify the maximum volume of air the lungs can contain. The procedure for performing this test varies from one practitioner to another, however the principle is that the patient inhales as deeply as possible, and slowly exhales all the air in the lungs.

4.9.2.1. Available features

Name	Description	Required	Result
Curve validation	Indicator to define the best curve realised by the patient. Only one curve can be validated per test. (ATTENTION: Automatic validation can be chosen).	A curve selected	Curve validated
Curve deletion	Deletes a curve from the graph	A curve selected	Curve deleted
Pre/post medication mode	Used to identify a curve to compare with others after going to post medication mode	A curve selected	The selected curve becomes the «pre» curve. All other curves are deleted.
Curve creation	Used to create a curve by pressing on the Start button to perform a spirometry test	SENSOLYSER® Q13® device connected	At the end of the test, the operator presses on the «Stop» button. The graph adapts to the displayed curves.
Curve selection	To calculate and display results, the operator can select a curve by clicking on the desired curve in the graph legend	Curves performed	Curve selected. Results calculated. Certain actions unlocked.

4.9.2.2. Interface presentation

The screenshot shows the Spirowin Expert software interface. Key components are labeled with callouts:

- Name of screen in progress:** Points to the top header area.
- Volume/time graph:** Points to the central graph showing volume over time.
- Graph legend:** Points to the bottom-left area of the graph.
- Patient information:** Points to the right-hand panel displaying patient details like name, age, height, and smoking status.
- Control Panel:** Points to the bottom-right area with buttons for 'Start', 'Previous', 'Next', and 'Cancel'.
- Results table:** Points to the table in the center-right showing test results.

Results	Value	Predicted
VC	4.66 L	1.90 L
ERV	2.38 L	-
IRV	0.40 L	-
IC	2.28 L	-
Tidal Volume	1.88 L	-

Note: Certain results from this type of test require a specific curve shape: ERV, IRV, IC and TV results, which require three normal inhalations and exhalations before the test.

4.9.2.3. Contextual menu

Test reports can be printed out or exported by right-clicking on the curves graph. A contextual menu appears with the following options:

- Print
- Export in PDF

4.9.3. Forced Vital Capacity test

Forced Vital Capacity test is a measurement of forced exhalation, i.e. the amount of air that can be exhaled with force after inhaling as deeply as possible. The patient remains upright. After 2 or 3 normal breaths, the patient inhales as deeply as possible and exhales all the air from the lungs into the spirometer, as forcefully as possible. The spirometry results are compared to the predicted values, which are calculated according to the age, gender, height and ethnic group of the patient. The FVC% expresses the percentage of the FVC in relation to this predicted value.

Note: The operator should ensure the patient empties **all** the air from the lungs.

4.9.3.1. Available features

Name	Description	Required	Result
Curve validation	Indicator to define the best curve realised by the patient. Only one curve can be validated per test. (ATTENTION: Automatic validation can be chosen)	A curve selected	Curve validated
Curve deletion	Deletes a curve from the graph	A curve selected	Curve deleted
Pre/post medication mode	Used to identify a curve to compare with others after going to post medication mode	A curve selected	The selected curve becomes the «pre» curve. All other curves are deleted.
Curve creation	Used to create a curve by zpressing on the Start button to perform a spirometry test	SENSOLYSER® Q13® device connected	At the end of the test, the operator presses on the «Stop» button. The graph adapts to the displayed curves.
Curve selection	To calculate and display results, the operator can select a curve by clicking on the desired curve in the graph legend	Curves performed	Curve selected. Results calculated. Certain actions unlocked.

4.9.3.2. Interface presentation

Name of screen in progress

Volume/time graph

Graph legend

Patient information

Timed exhalation

Control Panel

Volume/time graph

Results table

Résultat	Valeur	Prédits	
CVP	4,44 L	1,64 L	270
VEMS	3,62 L	1,22 L	296
DEP	10,19 L/s	4,81 L/s	211
VEMS/CV	77,68 %	65,68 %	118
VEMS/CVF	81,53 %	65,68 %	134
DEMM	3,51 L/s	0,99 L/s	369
DE75	9,40 L/s	4,15 L/s	226

Version du logiciel embarqué : V01.02.00
Température ambiante : 24,8 °C
Numéro de série : 191724
Pression atmosphérique : 99,8 kPa
Prochaine date de vérification usine : 18/04/2024
Humidité : 45 %

The timer starts with each new inhalation and is zeroed each time the exhalation is stopped. FVC exhalation time is calculated and displayed in the results table.

4.9.3.3. *Contextual menu*

Test reports can be printed out or exported by right-clicking on the curves graph. A contextual menu appears with the following options:

- Print
- Export in PDF

4.9.3.4. *Incentive*

For this Forced Vital Capacity test, SPIROWIN® EXPERT includes an Incentive to know whether the patient performs the test correctly.

Hang-glider Incentive: When the patient breathes normally, CAPSULITE walks across a field with his hang-glider. When the patient inhales deeply, CAPSULITE starts running. When the patient exhales all of the air in the lungs, CAPSULITE takes off and glides until the patient finishes breathing out. If the patient goes over the predicted FVC, the hang-glider lands correctly. If not, CAPSULITE falls to the ground.

Shot put Incentive: When the patient breathes normally, CAPSULITE spins slowly, holding the shot. When the patient inhales deeply, CAPSULITE starts spinning faster. When the patient exhales all of the air in the lungs, CAPSULITE throws the shot, which flies until the patient finishes breathing out. If the patient goes over the predicted FVC, CAPSULITE is happy with his result. If not, CAPSULITE is disappointed.

Note: The Incentive is displayed once the test is run. The Incentive window can be moved wherever the operator wishes, with a long click on it.

Caution: Flows in normal respiration should not be more than +/- 2 L/s so as to detect small flows during strong inhalation. A strong inhalation and a strong exhalation should last for at least 1 second.

4.9.4. *Maximum Voluntary Ventilation test*

The Maximum Voluntary Ventilation test quantifies the volume of air that can be mobilised for one minute, thus showing respiratory efficiency. The patient must breathe (inhalation/exhalation) as deeply and rapidly as possible for 12 seconds. The measurement is then extrapolated over 1 minute.

Caution: This test is not often performed in spirometry screening. It is potentially dangerous for the patient due to the fatigue and over-ventilation it causes.

4.9.4.1. Available features

Name	Description	Required	Result
Curve validation	Indicator to define the best curve realised by the patient. Only one curve can be validated per test. (ATTENTION: Automatic validation can be chosen).	A curve selected	Curve validated
Curve deletion	Deletes a curve from the graph	A curve selected	Curve deleted
Pre/post medication mode	Used to identify a curve to compare with others after going to post medication mode	A curve selected	The selected curve becomes the «pre» curve. All other curves are deleted.
Curve creation	Used to create a curve by pressing on the Start button to perform a spirometry test	SENSOLYSER® Q13® device connected	At the end of the test, the operator presses on the «Stop» button. The graph adapts to the displayed curves.
Curve selection	To calculate and display results, the operator can select a curve by clicking on the desired curve in the graph legend	Curves performed	Curve selected. Results calculated. Certain actions unlocked.

4.9.4.2. Interface presentation

The screenshot shows the Spirowin expert software interface. The main window displays a spirometry graph with volume (L) on the y-axis and time (s) on the x-axis. A purple curve represents the test data. The interface includes a patient information panel on the right, a control panel with buttons for 'Start', 'Previous', 'Next', and 'Cancel', and a results table showing MVV values. Callouts point to various elements: 'Name of screen in progress' points to the top header; 'Volume/time graph' points to the main graph area; 'Graph legend' points to the bottom-left corner; 'Patient information' points to the right-hand panel; 'Control Panel' points to the bottom-right control area; and 'Results table' points to the table in the center-right.

4.9.4.3. Contextual menu

Test reports can be printed out or exported by right-clicking on the curves graph. A contextual menu appears with the following options:

- Print
- Export in PDF

4.9.5. Test Assessment (This screen can be masked in the parameters)

At the end of the process, SPIROWIN® EXPERT displays a review of the test performed. A recapitulative of curves validated per test is displayed with the results. A comment can be added to the test in progress.

Interpretation Help for the Forced Vital Capacity test is supplied and is based on the curve validated for this test. Interpretation Help is detailed in chapter: §4.7.5.2.

4.9.5.1. Interface presentation

The screenshot displays the SpirowinExpert v04.00.00 interface. The main window is titled 'Rapport de l'examen' and 'Accueil'. The header includes the FIM Medical logo and contact information for FIM MEDICAL (51 rue Primat, 69100 Villeurbanne, France). The user is logged in as 'Admin'. The main content area shows a table of respiratory test results under the heading 'Capacité vitale'. The table lists parameters such as CV, VRE, VRI, CI, and VC, along with their values and predicted values. A 'Conclusion' field is present below the table. On the right side, a sidebar displays patient information for 'Casque Didier' (Age: 122 Ans, Taille: 174 cm, Non fumeur) and provides options to 'Imprimer', 'Exporter en PDF', and 'Exporter en CSV'. At the bottom right, a control panel contains navigation buttons: 'Précédent', 'Fin', and 'Annuler'. The footer of the interface shows technical details like 'Version du logiciel embarqué : V01.02.00', 'Température ambiante : 24,7 °C', and 'Prochaine date de vérification usine : 18/04/2024'.

Paramètre	Valeur	Prédits	Tendance
CV	4.66 L	1.90 L	% Prédits : 245,26 %
VRE	2.38 L	-	% Prédits : -
VRI	0.40 L	-	% Prédits : -
CI	2.28 L	-	% Prédits : -
VC	1.88 L	-	% Prédits : -

Note: An up, down or straight arrow icon immediately indicates the trend of the result between the predicted values and the obtained values.

Note: The test is recorded automatically after clicking the «END» button of the process.

4.9.6. Interpretation

4.9.6.1. Presentation

Interpretation Help is a support for the operator for his type of analysis in relation to the results of the Forced Vital Capacity test. This diagnostic support does not replace the opinion of qualified personnel; it simply directs the operator towards what to examine more closely on the respiratory function exploration performed.

Caution: This support does not take into account the state of health of the patient at the time of the test.

4.9.6.2. Interpretation Help for the Occupational Health practitioner

Help for the Occupational Health practitioner for diagnosis in relation to the results of a respiratory function exploration test.

Pathologies screened:

- Small airways disease (SAD)
- Obstructive ventilatory disorder (OVD)
- Restrictive ventilatory disorder (RVD)
- Mixed ventilatory disorder (MVD)

Determination procedure is described in the following flowchart:

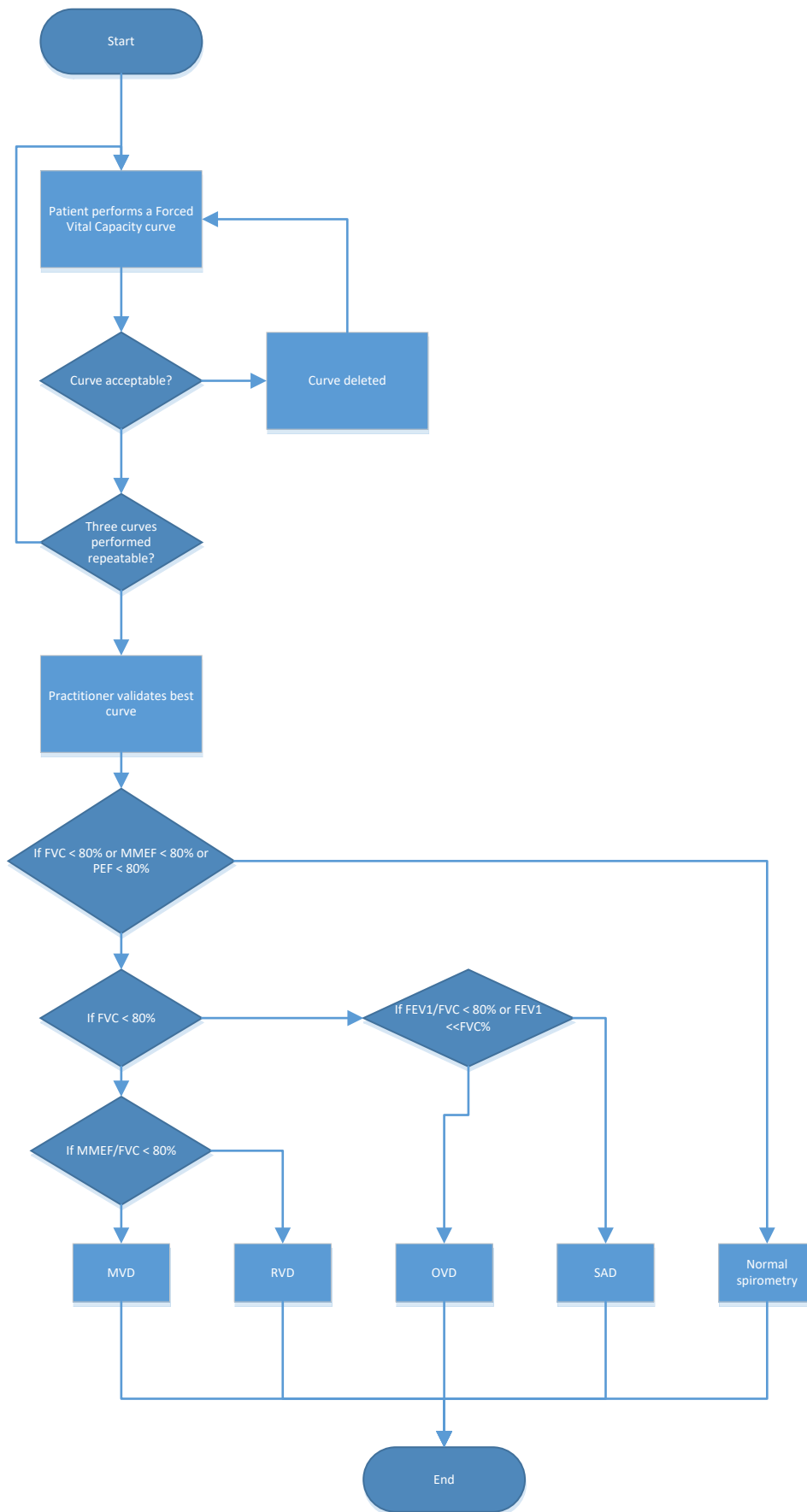

4.9.6.3. *Interpretation Help groups*

A. Perdrix, MCU-PH Lung specialist. Head of professional pathologies and work ability consultations, Grenoble CHU

It has appeared useful to simultaneously use several parameters including the two ratios FEV1/ FVC and MMEF25-75/FVC in order to see if people's diagnostic accumulation could enable earlier care in the genesis of certain respiratory problems.

Eventually, a 9-group classification was suggested, of which a part is represented in the attached outline.

The spirographic limits defining each group are reproduced in annex 1.

For more specific or particular information, refer to the book: " Guide pratique d'explorations fonctionnelles respiratoires. Utilisation en milieu professionnel ". A. Perdrix - Masson. 1994, 184p.

This logigram has been used partly in work and work ability pathology consultations in the framework of the CRAM convention, as well as in the framework of car-body painter craftsmen and industrial painters, CMR convention. It has also been validated in two metallurgic companies in Haute-Savoie by Dr. LEVAIN.

What are the recommendations according to each group?

The use of portable, validated spirometric equipment allows for detection in the work environment. Not all abnormal spirometric recordings indicate a pathology; at the very most, a functional abnormality, providing this abnormality is validated. This implies repeating the examination. Nevertheless, a specific case distorts these outlines: work-related asthma with variability of its reactivity. Effectively, it is not rare to find a large spirometric variation in a work-related asthmatic from one day to another. So, an abnormality noticed one day can very well be accompanied by a normal spirometric tracing the next day. If this is true, there are two plausible explanations: technique incorrectly performed, whatever the cause, or effectively, the second hypothesis which is related to the variability of work-related asthma. But, we will search for other simultaneous or successive criteria before casting a definitive diagnosis.

4.9.6.3.1. Group 1:

Normal tracing. This result should be reassuring. Nonetheless, it has already been suggested in the guide cited above, use of the drift in time of obtained figures, quoted in each individual's abacus in order to see if the regression gradient is superior to the physiological gradient of his reference group. A subject can be quite normal, but have a rapid regression in his performance while remaining above the normal limit values (refer to annex 2).

4.9.6.3.2. Group 2:

The subject presents a decrease of the ratios to a level esteemed still normal when each one is used separately. If the performances are verified, group 2 is the group which, 5 or 10 years later, strongly risks developing into an obstructive expiratory problem patent of a COAD. Work assessment is imperative in the search for harmful irritants, allergens or toxins inhaled via the respiratory tract. Enquiries must also be made into smoking and history. It is certainly a group to which preventative efforts must be brought considering this progressive threat. A spirometric check every two years is necessary with the same portable machine.

4.9.6.3.3. Group 3:

Includes those which we call carriers of small airways disease.

Recommence the test to be sure of the validity of the figures. That being so, the subject has 4 possible developments

- recovery and passage into group 1 due to numerous short-lived inflammatory pathologies
- persistence of the unchanged problem
- progressive passage towards an obstructive ventilation problem of the COAD (chronic obstructive airways disease) type, thereby joining the following group
- some cases can evolve into a restrictive problem. Spirographic checking every two years. Enquiries as for group 2 into respiratory history, irritants and work-related inhaled toxins and smoking.

4.9.6.3.4. Groups 4-5-6-7:

The significance of obstructive expiratory problems is defined by a decrease of FEV1/FVC lower than - 10% in relation to the norm.

If the abnormality is found, group 4 can again be considered as work medicine detection.

Previously unknown, groups 5, 6 and 7 (of a COAD) show the failure of early detection. A case already indicated above is the sudden appearance of an unknown obstructive problem. It can enter into the framework of an asthma for which a respiratory workup with betamimetic and methacholine tests are to be done. The other strategic tests for the research of work-related tendencies are to be seen. The diagnosis of group 4 noted for the first time warrants a lung specialist assessment.

For the groups 5, 6 and 7 it is not normally a question of detection but of known people, more or less followed by lung specialists. Surveillance by portable spirometry every year or every two years appears sufficient for a professional follow-up, independent of the surveillance organized by lung specialists. In all these groups, obtain very precise information on the diagnosis and the possible influence of added aggravating factors: inhaled irritants and toxins and smoking.

4.9.6.3.5. Group 8:

Or restrictive tendency. The word tendency is used because, with a portable spirometer, the absence of residual volume does not allow for calculation of total pulmonary capacity and thus, confirmation of restrictive syndrome. On the other hand, significant lowering of vital capacity with FEV1/VC still within the norm directs us towards a restrictive tendency. There also, before this reality is confirmed, it is necessary to recheck with a portable spirometry. The aetiologies which give restrictive tendencies do not develop from one second to the next as in the obstructive problem of asthma. There is more time to check. If the new results are identical, check the ethnic group and the associated correction (refer to: "Guide pratique.....") It is usual to admit that a reduction of volumes and flows lower than the inferior limits of the norm should lead to a lung specialist check if this abnormality is unknown and if there is no history or obesity that can give indications. Displace the discussion with clinical and radiological elements.

4.9.6.3.6. Group 9:

Mixed problems. With only a simple spirometry, and no residual volume, it is a group with an extremely difficult approach. It is the case where lowering of volumes and flows is very large with a minimal but still significant lowering of ratios. Mixed problems can only be confirmed by a lung specialist measurement of residual volume. In the case of an unexpected discovery, refer to the aetiology dictionary (refer to: "Guide pratique...") and the recommendations it suggests.

4.9.6.4. GOLD (Global Initiative for Chronic Obstructive Lung Disease) interpretation help

Chronic obstructive pulmonary disease (COPD) is a clinical diagnosis that is still based on patient history, symptoms and respiratory function exploration. The GOLD directive provides help and a working method for the screening of COPD.

Realisation method

To perform a COPD screening using the GOLD interpretation help you must firstly perform a reference curve named Pre-curve. Then you must perform a Post-curve on the patient (after administering bronchodilator) by clicking on "define the validated curve as reference in Pre mode". (Caution: only under medical surveillance).



Lastly, once an acceptable Post-curve is obtained, the following panel gives the automatically calculated GOLD interpretation.

Possible values:

I: Slight COPD	<ul style="list-style-type: none"> • FEV1/FVC < 0.7 • FEV1 ≥ 80% of predicted values 	At this stage the patient may not be aware of his pulmonary function abnormality.
II: Moderate COPD	<ul style="list-style-type: none"> • FEV1/FVC < 0.7 • 50% ≤ FEV1 < 80% of predicted values 	At this stage symptoms generally develop depending on patient effort.
III: Severe COPD	<ul style="list-style-type: none"> • FEV1/FVC < 0.7 • 30% ≤ FEV1 < 50% of predicted values 	Breathlessness worsened and often limits patient daily activities. At this stage exacerbation is especially noticeable.
IV: Very severe COPD	<ul style="list-style-type: none"> • FEV1/FVC < 0.7 • FEV1 < 30% of predicted values • FEV1 < 50% of predicted values + chronic respiratory insufficiency 	At this stage quality of life is very diminished and exacerbation could put the patient's life in danger.

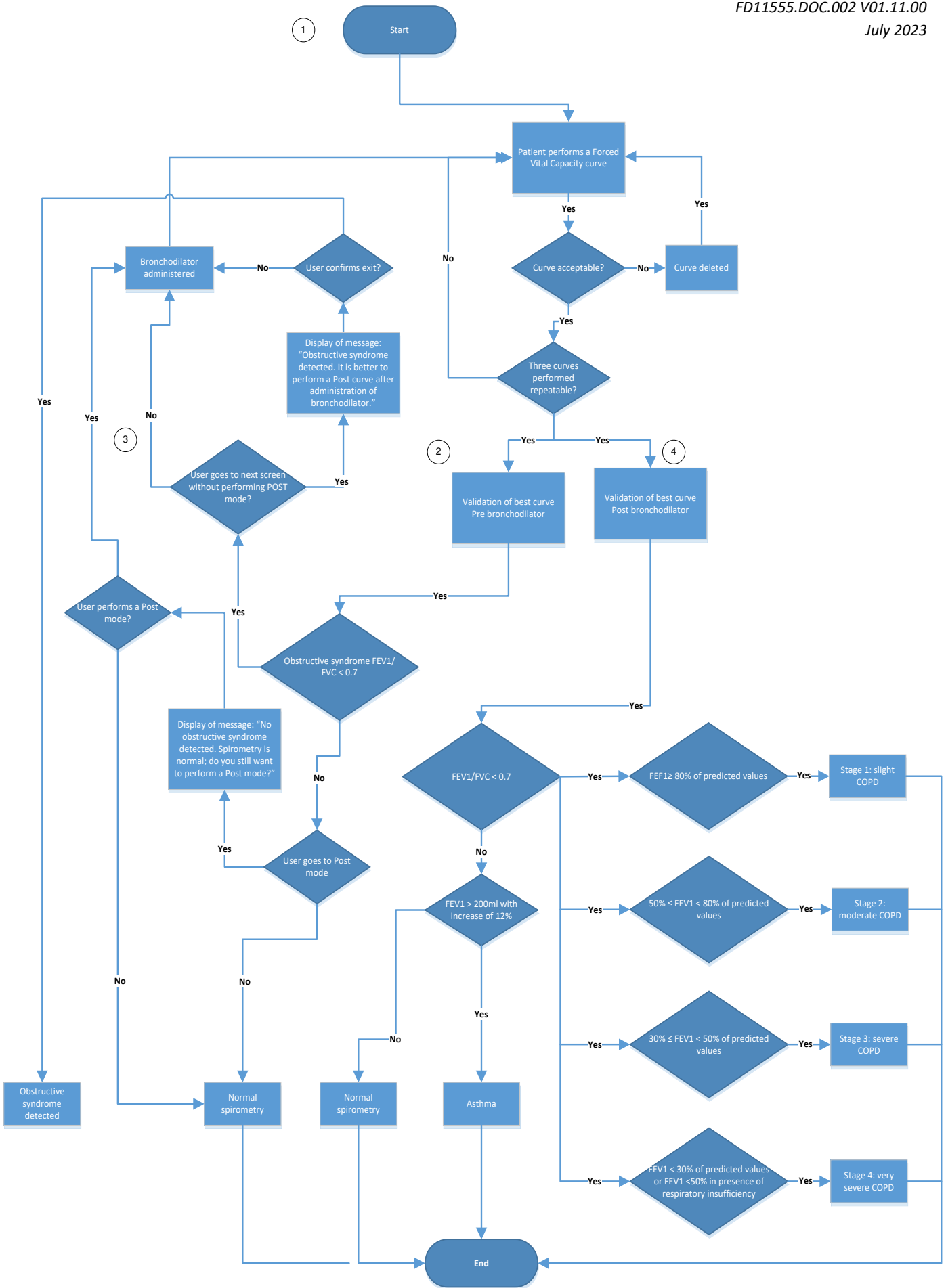

4.9.6.5. Available features

Name	Description	Required	Result
Add a comment	The operator or practitioner can add a comment at the end of the test. This is linked only to the test in progress and not to the patient.	Tests performed	Conclusion comment on test performed
Print	Test report printed according to application setup	Tests performed	Printout on selected printer
PDF Export	Test report exported according to application print setup	Tests performed	Export of test report in a PDF file to selected place
CSV Export	Export of results in CSV format according to table 8 “Standardization of Spirometry” Eur Respir J 2005	Tests performed	Export to a CSV file at the selected place

Note: If «PDF Export Automatic» is selected in the setup, this will take place during recording, when «END» button is clicked.

At the end of the test and after printing, the operator should click or press on «END» button to exit Create a Test mode. The application then asks the operator if the test is to be saved.

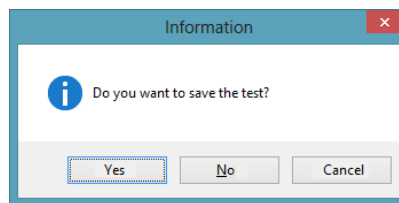

This message is then displayed for correct recording:

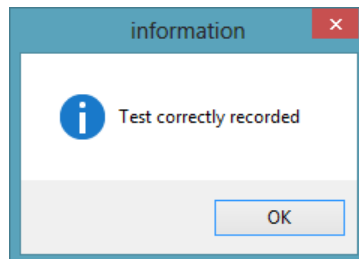

4.10. Test Management

For data safety reasons, a test performed and recorded in the database can no longer be modified.

However, it can be:

- viewed
- printed
- exported
- deleted

A test can be opened by several ways:

In the Home page is a list of the last tests performed on the application. Click right on the desired test to open, print, export or delete the test.

From the «Open a Test» link on the Home page, access management of all tests recorded in the database screen. Searches can be made by patient and date performed.

4.10.1. Test Management screen presentation

The screenshot displays the SpirowinExpert application interface. On the left, a list of tests is shown, with a blue callout box labeled "List of tests" pointing to it. The list includes patient names, birth dates, ages, and exam dates. On the right, a search form is visible, with a blue callout box labeled "Search form" pointing to it. Below the search form is a control panel with a blue callout box labeled "Control Panel" pointing to it. The control panel contains buttons for "Ouvrir", "Imprimer", and "Annuler". The interface also shows a header with "FIM MEDICAL" and "Spirowin EXPERT" logos, and a footer with technical information.

Click «Search» button to validate the search filter.

Select a test to open or delete.

Note: Click on right button to: Open, Delete, Print or Export in Pdf file.

4.11. Identification Management

As stated in preceding chapters, each file in the SPIROWIN® EXPERT application is an identification file. This can be:

- Patient
- Operator
- Company

The management of all identification files is done through the same interface, accessible via the Home page, by clicking «Identification Management».

The screenshot shows the 'Gérer les identifications' interface. On the left, a list of identification files is displayed, including details like name, birth date, and age. On the right, a 'Recherche' panel allows searching by name, patient ID, operator, or company. Below the search panel is a 'Control Panel' with buttons to 'Ajouter une fiche patient', 'Ajouter une fiche opérateur', and 'Ajouter une fiche entreprise'. At the bottom, there are status indicators for software version, serial number, and environmental conditions.

Use this screen to:

- Add a new file
- Modify existing files
- Delete one or several files
- Search for a file
- Define a company file as default company by the contextual menu

4.11.1. Add a new file

To add a new file, click one of the «Add» buttons on the Control Panel on the right of the screen. A window appears with the identification fields. Certain fields are compulsory or have their own properties. Each of these indications is displayed below the relevant field.

4.11.2. Modify an existing file

To modify an existing file, click twice on the relevant file in the list.

A window appears with the identification fields. Certain fields are compulsory or have their own properties. Each of these indications is displayed below the relevant field.

4.11.3. Delete a file

To delete a file, click on a file in the list of identifications and click «Delete» button.

To delete several files, select several files by holding down the Control key whilst selecting other files. Then click «Delete» button.

4.11.4. File search

To search for a patient, company or operator file, use the last name, first name or ID in the search field of the Control Panel on the right of the screen. Validate the search by clicking or pressing «Search» button.

4.11.5. Patient file

- Patient identification

Surname: <input type="text"/>	First name: <input type="text"/>
<small>Empty field Field must have between 2 and 50 characters</small>	<small>Empty field Field must have between 2 and 50 characters</small>
DOB: <input type="text" value="09/12/2016"/>	ID: <input type="text"/>
<small>Patient age must be between 6 and 150 years</small>	<small>Empty field</small>
Height: <input type="text"/> inches	Gender: <input type="text"/>
<small>Empty field</small>	<small>Empty field</small>
Weight: <input type="text"/> pounds	Ethnic group: <input type="text" value="Caucasian"/>
Address: <input type="text"/>	Smoker: <input type="text" value="Non smoker"/>
Prescriber: <input type="text"/>	Company: <input type="text"/>
Comments: <input type="text"/>	Department: <input type="text"/>
	Occupation: <input type="text"/>
	Exposure: <input type="text"/>

The patient file is used to define information concerning the patient. It is composed of the following elements:

Name	Compulsory	Field can be masked	Description
Last name	X		Patient last name
First name	X		Patient first name
DOB	X		Patient DOB
ID	X		Identification field used by operator
Height	X		Patient height in cm or inch according to parametering
Gender	X		Male or female
Ethnic group		X	Defines ethnic group of a patient for specificity of certain predicted values
Weight			Patient weight in kg or lb depending on parametering
Prescriber			Name of prescriber requesting spirometry test
Smoker	X		Cigarettes (smoker, ex-smoker, non-smoker)
Occupation			Patient occupation
Department			Department within the company
Company			Company name
Exposure			Patient respiratory exposure
Address			Patient address
Comments			Operator comment on the patient

4.11.6. Smoking Pack Year

The «Smoking Pack Year» (SPY) is a unit of measurement for a numbered representation of a person's smoking history during his lifetime. The «Smoking Pack Year» is calculated by multiplying the number of packets smoked per day by the number of years a person smoked.

e.g.: 1 SPY = 20 cigarettes per day for one year.

The representation of a patient's smoking history is important in clinical care, where the level of exposure to tobacco is correlated with the risk of illnesses such as lung cancer.

Equations used in the software:

Smoking types	Smoking Pack Years calculation
Cigarettes	$((\text{number of cigarettes per day}) \times (\text{years of smoking})) / 20$
Cigarillos	$((\text{number of cigarillos per day}) \times (\text{years of smoking})) / 20 \times 2$
Cigars	$((\text{number of cigars per day}) \times (\text{years of smoking})) / 20 \times 4$
Pipes	$((\text{number of pipes per day}) \times (\text{years of smoking})) / 20 \times 2.5$
Joints	$((\text{number of joints per day}) \times (\text{years of smoking})) / 20 \times 4$
Tobacco (g)	$((\text{number of grams per week}) \times (\text{years of smoking})) / 70$
Water pipe (20 min session)	$((\text{number of water pipes per week}) \times (\text{years of smoking})) / 20 \times 3.5$

To access this calculation fill in the patient's smoking or non-smoking history in the patient identification file. An extra panel appears:

Simple to use. Indicate:

- Type (cigarette, cigarillo, cigar, pipe, joint, loose leaf tobacco, water pipe)
- Number per day (or number of grams per week for loose leaf tobacco, or number of sessions per week for the water pipe)
- Number of years

Then click the button to take the line into account in the calculation. (possible to remove each added line).

«Smoking Pack Year» is thus automatically calculated:

Each input data is then recorded with the patient file. This result is also indicated during the patient test as well as on the report printout.

4.11.7. Operator file

The definition of a password and response to a question is compulsory for operator files to reset the password. Even if the system is down.

Name	Compulsory	Description
Last name	X	Operator last name
First name	X	Operator first name
Occupation		Operator occupation
Password	X	Operator password
Password confirmation	X	Confirms password identical
Question	X	Chooses password recovery question
Answer	X	Answers password recovery question

4.11.8. Company file

Test reports can be personalised with the company name, details and logo. The FIM MEDICAL company is recorded by default.

Name	Compulsory	Description
Name	X	Operator last name
Address		Company address (in 2 fields)
Supplement		Additional address
Zip code		Zip code
City		City
State		State
Country		Country
Logo		Company logo (bmp, jpg, png, gif)
Phone number		Company telephone number
Fax number		Company fax number
Email		Company email
Company selected for the application		Defines the company as selected for the application

Selection of a company for the application:

In the SPIROWIN® EXPERT application, only one company can be defined as default company. By defining a default company, the company identity can be used on test, check and software reports.

To define a company by default in the application, either:

- Tick the box in the creation/modification of a company file.
- Click right on a company file, then «Define as Default Company» in the displayed contextual menu.



4.12. Test Comparison

Through the Home page, the operator can compare several tests performed on the **same** patient by clicking on «Compare Existing Tests».

4.12.1. Comparison presentation

To compare existing tests please select a patient and the type of test.

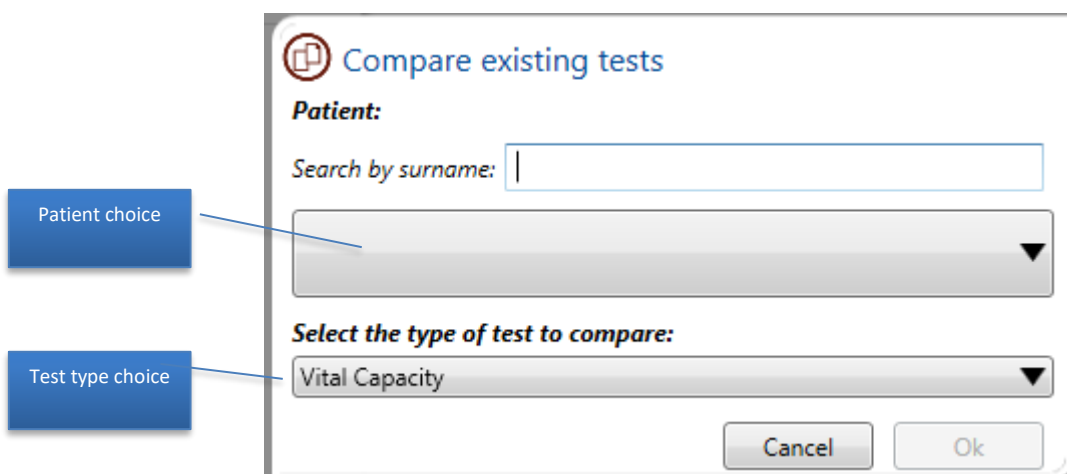

Then click « Compare the Curves » (**button clickable only when two or more curves are selected**).
This screen appears:

The screenshot displays the SpirowinExpert software interface. At the top, it shows the FIM Medical logo and contact information, along with the user's name (Martin John, Nurse) and the Spirowin logo. The main area is titled "Compare existing tests" and "Home". A dropdown menu shows "FEV1" as the selected test. Below this, a table lists several dates with checkboxes and star icons, representing selected results for comparison. To the left, a graph shows multiple overlapping curves. To the right, a larger graph displays the "Volume (L)" over time for the selected result, with a purple dot indicating the start of the test. A patient information panel on the right side provides details for "Eyppey Jean-Noël", including DOB, age, and smoking status. At the bottom, there is a "Redo an examination comparison" button and a "Print" button. A status bar at the very bottom displays technical information like "Embedded software version", "Ambient temperature", "Serial number", "Atmospheric pressure", "Next factory check date", and "Humidity".

The graph shows the course of the selected result. It is refreshed at each change of results in the list.

Tests are only compared to help the practitioner with patient follow-up.

Click on Print to print the comparison and the evolution curve.

Note: If the operator did not validate a curve for this type of test, the software displays a user information message.

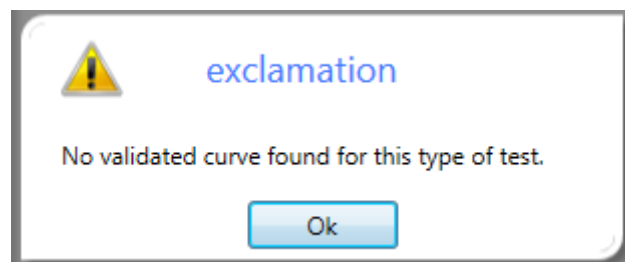

4.13. Device Calibration Check Certificate

Using the QFlow® sensors, the SPIROLYSER® Q13® device measures a difference in pressure to obtain flows and volumes according to the FLEISCH principle. With this patented system the SPIROLYSER® Q13® does not need calibration. However, and according to the ATS 2005 recommendations, SPIROWIN® EXPERT proposes to certify that the entire device is functioning correctly.

To access the check, click «Check Sensor Calibration» in the Home page. The following screen appears:

The screenshot shows the 'SpirowinExpert' software interface. At the top, there is a header with 'FIM Medical' logo and contact information, and 'Spirowin expert' logo. Below the header, there are navigation links: 'Paramètres', 'Aide', 'Déconnexion'. The main content area is titled 'Vérifier l'étalonnage du capteur' and 'Accueil'. It features a graph on the left with 'Débit (L/s)' on the y-axis and 'Volume (L)' on the x-axis. A blue shaded area is visible in the graph. To the right of the graph is a table with the following headers: 'Débit atteint (L/s)', 'Volume mesuré (L)', 'Volume théorique (L)', 'Différence (L)', 'Erreur (%)', and 'Erreur maximale tolérée (%)'. On the far right, there is a 'Seringue' configuration panel with fields for 'Fabricant', 'Description', 'Type', 'Series', 'Numéro de série', 'Volume (L)', 'Tolérance (%)', and 'Prochaine date de vérification'. At the bottom of the interface, there are status indicators for 'Version du logiciel embarqué', 'Numéro de série', 'Prochaine date de vérification usine', 'Température ambiante', 'Pression atmosphérique', and 'Humidité'.

The check is done in three steps, by validating for each flow, that the measurement of the volume does not exceed +/- 3.5 % (including syringe check error) compared with the volume sent.

The screen has three control buttons on the bottom right of the check screen:

- Cancelled => Exits check screen
- Next => To go to following step. Only possible if the curve of the step in progress is traced
- Start/Stop=> Check curve is traced (if a curve exists, it is automatically replaced)

4.13.1. ATS 2005 recommendations check procedure

Stage 1 (2L/s flow):

Connect the check syringe to the spirometer which is connected to the computer running the SPIROWIN® EXPERT software. Press the «Start» button and pull the syringe piston, whilst aiming to keep the curve within the template traced on the graph. At the end repeat in the opposite direction. At the end click on the «Stop» button. If the tracing is unsatisfactory, repeat this stage by re-clicking on the «Start» button. Or click on the «Next» button to validate stage 1 and go to stage 2.

Stage 2 (6L/s flow):

Press on the «Start» button and pull the syringe piston whilst aiming to keep the curve within the template traced on the graph. At the end, repeat in the opposite direction. At the end, click on the «Stop» button. If the tracing is unsatisfactory, repeat this stage by re-clicking on the «Start» button. Or click on the «Next» button to validate stage 2 and go to stage 3.

Stage 3 (12L/s flow):

Press on the «Start» button and pull the syringe piston whilst aiming to keep the curve within the template traced on the graph. At the end repeat in the opposite direction. At the end click on the «Stop» button. If the tracing is unsatisfactory, repeat this stage by re-clicking on the «Start» button. Or click on «End» to validate stage 3, and print out your device calibration check certificate.

Note: The SPYROLYSER® Q13® device check report is printed out at the end of the procedure. Printing can be done normally or as PDF export.

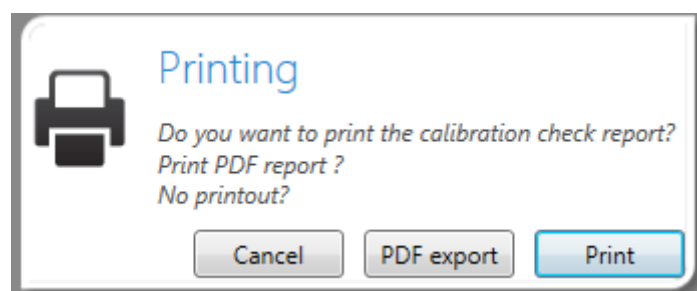

4.14. Application Parametering

4.14.1. Presentation

All of the application parameters can be modified in this part. The screen is composed of the following parts:

4.14.2. General

Available Parameters:

Name	Action
Use of a filter during the test.	Allows you to pre-fill the choice of whether or not to use a filter during the test. 3 choices: Yes (Always), No (Never), I will decide during the test.
Standard Compliant	Activates the recommendation selected during the exam
Date format	Formats application dates
Address format	Address format in software and reports
Height/weight units	Changes height and weight units
Temperature units	Changes temperature units
Atmospheric pressure units	Changes atmospheric pressure units
Language	Application language
Id/Password	Use of authentication system when application is run
Database type	Application database type (local or network)
Database file	Directory of database in local mode
Synchronisation of old FIM MEDICAL database	Uses old database to synchronise patient files between all the FIM MEDICAL software
User Manual file	Defines the User Manual directory
Computer quality code (ATS)	Defines the quality level of the software
Disable hardware acceleration.	Allows you to use the display capabilities managed by the microprocessor (CPU) rather than the capabilities of the integrated or external graphics card (GPU).

4.14.3. Guest mode

Available Parameters:

Name	Action
Choosing modes	Text, HL7 or XML mode.
Default settings.	Uses the software's default settings.
Swap directory for the file	Forces the swap directory.
Swap file name	Forces the swap file name
Also saves to a local database.	Saves the tests in GUEST mode and to the database.
File sampling	Opens the swap file as soon as it is modified
Application in the notification bar	Hides the application in the notification bar
Creates a GUEST3 mode short cut.	Creates a short cut on the desk with the above settings.
Copy to the clipboard.	Copies the short cut settings to the clipboard.

4.14.4. Tests

Test parameters define the features of performing a test.

Available Parameters:

Name	Action
Predicted values	Choice of predicted values for Interpretation Help <ul style="list-style-type: none"> • Knudson • Crapo (ITS) • ECCS / Zapletal • ECCS / Polgar • NHannes III • Dejsomritrutai 2000 • GLI
Ethnic groups	Use of ethnic groups in patient identification and calculation of predicted values
Order of DE25 and DE75 values	Definition of DE25 or DE75 parameters
Volume/Time Curve	Defines the time/curve display. Complete or only expiry only.
Choice of results	Defines the results displayed by type of test in the application
Lung age	Activates/deactivates lung age calculation (calculation for information only)
Curve smoothing	SPIROWIN® EXPERT displays the real image of the breath that passes through the QFlow® sensor. For clearer viewing, the curve display can be averaged and thus, the curve is smoothed.
Manual meteorological parameters	The software proposes the user to enter his own temperature, humidity or pressure values
Display of assessment at the end of a test	Deletes the last assessment display panel at the end of a test
Interpretation Help	Defines or deactivates Interpretation Help
Automatic validation of curves	For each test, the practitioner must choose a curve from those traced. With this option, the software automatically chooses the best of each new curve traced by calculating the best (FVC+FEV1) sum.

➡ **Caution:** Meteorological information displayed by the software is informative only, and not guaranteed. Only a weather station calibrated and located in the test room could give exact information.

4.14.5. Printing

The print parameters define the test report features for standard printing as well as for PDF export.

Available Parameters:

Name	Action
Type of report	Defines either summarised or complete report
Choice of results	To choose the results to display in the test report
Only validated curves	Activates/Deactivates if the application uses the validated curves for the test reports

4.14.6. Automatic PDF and CSV export

The automatic PDF report export option enables exportation at the end of the test without operator request.

It is also possible to automatically export the results in a CSV format according to table 8 'Standardisation of Spirometry' Eur Respir J 2005.

Available Parameters:

Name	Action
Activation	Activates/deactivates the report automatic export
Export path	Choice of automatic export file of the reports
File name	Choice of variables for creation of automatic report: [NAME] => Patient last name [FIRSTNAME] => Patient first name [ID] => Patient ID [DATE] => Test date (Compulsory) [HOUR] => Test time (Compulsory)
Separator	Selects the separator (CSV only).

4.14.7. Incentive

The Incentive guides the user and the operator during a Forced Vital Capacity test.

Available Parameters:

Nom	Action
Activation	Activates/Deactivates Incentive during the test
Choice of Incentive	Changes Incentive theme

4.15. User Manual

The User Manual file is defined in the application parametering. The choice of file is done automatically when the application is installed.

Note: A version of Adobe Reader must be installed at the workstation to display the User Manual.

To display the User Manual in the software, click on the «Help» menu at the top of the software window.

4.16. Third Party Software Use Mode (GUEST Mode)

4.16.1. Presentation

The SPIROWIN® EXPERT application has several extra commands so as to meet the needs of third party software using SPIROWIN® EXPERT. For this, parameters can be added in the running command line of the application.

4.16.2. Table of available commands

Name	Default Value (if existing)	Description
/GUEST3		Defines going to Host mode
/T	Mode by default if not specified	Text mode
/F:<File path>	Local database path	Forces the path and the file name to Text mode
/X		XML format
/O:< File path >	Local database path	Forces the path and the XML file name (OutData)
/I:< File path >	Local database path	Forces the path and the XML file name (InData)
/HL7 /ip:xxx.x.x.x /port:xx	/hl7 /ip:127.0.0.1 /port:7080	HL7 mode
/H		Application goes to Icon mode when minimised
/S		Polling mode of swap file
/Usebdd		Use of test recording and patient file in database

4.16.3. Host mode

4.16.3.1. Presentation

Host mode used for the exchange of data between SPIROWIN® EXPERT and a third party software. This is run with the /GUEST3 command.

- Text Mode (by default)
- XML Mode
- HL7 mode

4.16.3.2. Text format

4.16.3.2.1. Presentation

Host mode is in Text format by default. This Text format is chosen with the /T command. The name and path of the swap file can be passed as a parameter in SPIROWIN® EXPERT on the command line: «/F:<file name>». This path will be used to store the file containing the samples of the curve (s). Without this parameter, SPIROWIN® EXPERT will work with a file named IO_DATA.TXT in the application directory.

Eg:

```
C:\Program Files\Fim\Spirowin®\Spirowin®.exe /GUEST3 /F :C:\MyData\Ech.txt
```

Here the swap file will be Ech.txt and will be found in the C:\MyData\ directory.

4.16.3.3. Format of Swap File in Text Mode

The format used is that used by WINDOWS with the *.ini files. It is easily accessible with the WINDOWS API:

[Section]

Entrée=Value

Section is always the same: «Resultat»

File name is IO_DATA.TXT

4.16.3.4. Use

The input file is placed in the working directory of SPIROWIN® EXPERT, then the application is run with the «/GUEST3» parameter on the command line.

If the «Test Date» fields are filled in, SPIROWIN® EXPERT loads the tests according to the parameters found in the file. Otherwise, it is a new test.

Parameters required for calculation of standards are «DATE OF BIRTH», «HEIGHT» and «GENDER».

When the session is over SPIROWIN® EXPERT updates an output file with ID and results. The sample files are stored in the SPIROWIN® EXPERT folder. Their names are indicated in the results of each test. In this mode, SPIROWIN® EXPERT is not maintaining its database. Management of results and sample files is thus the responsibility of the application that has run it.

4.16.3.5. Parameter

- [Resultat] ← Section name compulsory.
- Parameter = parameter value

Parameter	Type	Description
Nom	String	Patient surname
Prénom	String	Patient first name
Id	String	Patient ID
Date de naissance	String format (DD MM YYYY)	Patient birth date
Adresse	String	Patient address
Profession	String	Patient job
Exposition	String	Patient exposure
Notes	String	Patient note/comment
Age	Int	Patient age (not necessary)
Poids	Double (with a dot)	Patient weight
Taille	Double (with a dot)	Patient height
Sexe	String (Male/Female)	Patient gender
Fumeur	String (Yes/No/Ex)	
Norme	String (CECA/Knudson/Polgar/Nhannes/ITS, Dejsomritrutai 2000, GLI)	Standard for predicted values
PDF	String	Indicates path and name of PDF file automatically generated if it exists

4.16.3.6. XML Format

Contact FIM MEDICAL for more information.

4.16.3.7. HL7 mode

HL7 Mode (Health Level Seven) allows to swap data with any software which has this feature.

When SPIROWIN® EXPERT is in HL7 Mode, 'HL7 Mode' shows in the title bar, the IP address and the scanned port. If a client's software connects to SPIROWIN® EXPERT, the word "Connected" appears.

 SpirowinExpert 02.05.00 - HL7 mode IP=127.0.0.1 :7080 Connected

4.16.4. Use of local database

GUEST mode does not use recording in database by default. It can, however, be done by adding /usebdd to the list of parameters when running the application.

4.16.5. Polling mode

Polling mode is used to swap data with a third party software that is unable to run the application with command lines. The SPIROWIN® EXPERT software should poll a folder to read regularly, if a new file has been created.

4.16.6. Icon mode

This mode places SPIROWIN® EXPERT as an icon in the Windows taskbar. The software only opens to do a test. This mode peers with GUEST mode or Polling mode.



5. Cleaning – Maintenance

The technologically innovative design of the SPIROLYSER® Q13® and the Qflow® sensor minimise the risk of cross-contamination between patients.

Bacteriological tests performed by the **Public Health England** (Salisbury - UK) laboratory show that the internal design of the product, associated with the Qflow® sensor, decreases the risk of patient cross-contamination to 99.999% if the Qflow® sensor is changed between each patient. Its innovative design also avoids contamination in the non-accessible internal parts.

5.1. List of Generic Bactericidal Fungicidal Products Validated by FIM MEDICAL

Due to a large number of brands and references of disinfectant wipes on the market, FIM MEDICAL has validated references for its products that do not alter the appearance or resistance of the plastic materials in the shells of its equipment.

For decontaminating its Spirolyser® Q13®, the FIM MEDICAL company authorises the use of the following impregnated cloths or wipes:

- 70% isopropyl alcohol
- Bactinyl® disinfection wipes
- Clorox® Healthcare Bleach
- Sani-Cloth® Bleach
- Sani-Cloth® Plus
- Sani-Cloth® HB

- Super Sani-Cloth®
- Sanicloth® AF3
- Formula 409®
- Virex® Plus
- Mikrozyd® AF Wipes
- Mikrozyd® Universal Wipes Premium

5.2.Clean the Housing

For hygiene measures, the surfaces of the SPIROLYSER® Q13® in contact with the skin (housing) must be disinfected between tests. The housing can be cleaned with a damp cloth and a generic bactericidal-fungicidal product (see §5.1).

- **Warning:** Never sterilise the SPIROLYSER® Q13® or its consumables
- **Warning:** Never clean the SPIROLYSER® Q13® under running water or immerse directly into any sort of liquid
- If the housing degrades, contact the FIM MEDICAL company or your distributor to change the equipment

5.3.Clean the Sensor Insertion Piece

The FIM MEDICAL company recommends the use of a bactericidal-fungicidal product such as scent-free wipes to clean and disinfect the inside part of the sensor insertion piece (cylinder) (see §5.1).

- **Warning:** The use of a single-use sensor does not exempt the equipment from disinfection
- **Warning:** Never sterilise Qflow® single-use components, SP1® SP1M® filter.
- If the device or the sensor insertion piece degrades, contact the FIM MEDICAL company or your distributor to change the equipment

5.4.Clean the Check Syringe

There are several calibrated syringe manufacturers on the market for checking spirometers. Whatever the syringe, it should only be used with a spirometer that has been disinfected, and a new Qflow® sensor.

Refer to the Instructions delivered with your syringe.

5.5. Daily Check

Conform with ATS/ERS the spirometer should be checked daily to ensure the equipment is operating correctly. Use a 3L calibrated syringe and follow the procedure explained in the Calibration Check chapter.

If the device malfunctions, contact the FIM MEDICAL After Sales Service department.

Warning: Whatever the brand, ensure to check the calibration syringe validity date, as well as its conditions of use, especially environmental conditions.

Due to the specific design of the Qflow[®] sensor, to obtain precise inspiration/expiratory values whilst checking with the calibrated syringe, it is imperative to use the specific FIM MEDICAL coupling connector between the Qflow[®] sensor and the syringe.

FIM MEDICAL recommends the use of a **HANZ RUDOLPH SERIES 5570** type syringe. If other syringe references are used, please contact FIM MEDICAL for a specific coupling connector.

5.6. Annual Maintenance

The SPIROLYSER[®] Q13[®] spirometer must be checked annually.

Only the FIM MEDICAL company or its approved distributors are authorised to perform annual services of its spirometers.

A calibration certificate shall be issued.

Warning: The device must be recalibrated every year. After this date, a drift may falsify results.

5.7. Guarantee

The SPIROLYSER[®] Q13[®] has a 2-year guarantee. Within the framework of the contractual guarantee, only repairs are covered. The guarantee is only applicable if normal and usual conditions of use are respected. During annual maintenance, a certain number of preventive operations are performed; breakdowns following annual maintenance are not covered by the guarantee.

5.8. Lifetime

The lifetime of the SPIROLYSER[®] Q13[®] is determined at 5 years on the condition that the user carries out the required maintenance as outlined in the above maintenance section.

FIM Médical will not be held liable for any degradation of performance in the case of failure to carry out these required maintenances.

6. Available Accessories

6.1. Litre Check Syringe

Conform with ATS/ERS, a fixed and calibrated volume is required to check correct function of the SPIROLYSER® Q13®. If you need a check syringe, contact the FIM MEDICAL company or your distributor.

6.2. Qflow® Single Use Sensor

FIM MEDICAL has specifically developed disposable sensors and filters for use with the SPIROLYSER® Q13®.

This single-use component **must be replaced** between each patient.

If the component is not changed, but reused between patients, there is a risk of cross-contamination (bacterial or viral when the sensor is placed in the mouth or during inspiration).

If you require Qflow® sensors, SP1® or SP1M® filters, contact FIM MEDICAL or your distributor. Different product packages are available.

6.3. SP1® / SP1M® filter

FIM MEDICAL has specifically developed single-use filters for use with FIM Medical spirometers (see SP1® and SP1M® filter instructions for more information).

This single-use component **must be replaced** between each patient.

If the component is not changed, but reused between patients, there is a risk of cross-contamination (bacterial or viral when the sensor is placed in the mouth or during inspiration).

If you require SP1® or SP1M® filters, contact FIM MEDICAL or your distributor. Different packaging is available. Different product packages are available.

6.4. Single Use Nose Clip



Use of a nose-clip is recommended by the ATS / ERS. The single-use FIM MEDICAL nose clip, delivered in individual sachets, optimises results by guaranteeing minimal air leakage during patient inhalation and exhalation.

This single-use nose clip must **absolutely** be replaced between each patient.

If the sensor is not changed, and reused between two patients, there is a risk of cross-contamination (bacterial or viral) when touching the nose.

If you need nose clips, contact the FIM MEDICAL company or your distributor.

Different product packages are available.

Note: Used accessories should be included in a separate collection for biologically contaminated waste (PIMW: potentially infectious medical waste).

7. F.A.Q.

Problems	Solution
Software does not start	<ul style="list-style-type: none"> • Reinstall SPIROWIN® EXPERT • If the problem persists, check the directory rights c:\ProgramData\FIM\Spirowin® • If problem persists, contact After Sales Service
Patient files or tests not found	<ul style="list-style-type: none"> • Ensure recording is working • Contact After Sales Service
Software does not detect the spirometer	<ul style="list-style-type: none"> • Turn off the programme • Unplug the spirometer • Reconnect the spirometer • Run the programme and check • If problem persists, contact After Sales Service
Windows® does not detect the spirometer	<ul style="list-style-type: none"> • Contact After Sales Service
Spirometer is detected but no curve traced	<ul style="list-style-type: none"> • Turn off the programme • Unplug the spirometer • Reconnect the spirometer • Run the programme and check • If problem persists, contact After Sales Service
Installation key not working	<ul style="list-style-type: none"> • Check the key located on the back of the CD sleeve is used • Contact After Sales Service

After Sales Service:

*FIM Medical After Sales Service
 51 Rue Antoine Primat
 CS 60194
 69625 Villeurbanne cedex
 Tel: (+33) 04 72 34 30 34*



*Thank you for reading this manual.
If you require further information please don't
hesitate to contact us.*



FIM MEDICAL

51 rue Antoine Primat, CS 60194 - 69625 Villeurbanne -
FRANCE

Tel: +33 04 72 34 89 89 - Fax: +33 04 72 33 43 51

Email: contact@fim-medical.com